



The Most Durable Chinese Lighting

Product Catalog



The Most Durable Chinese Lighting

4 operation centers at home and abroad.
10 production bases with research & development center.
60 professional engineers and 3900 workers.
VMAX is providing more than 400 customers
from 58 countries with distinctive
LED commercial items.

VMAX Operation Centers are established all over the world.
We can provide you with convenient and quality services anytime.



Manufacture



Application Case



The hotel lobby and other public places such as shops, need to create a spectacular and gorgeous space effect. Not only in the Lord to ensure the environmental light quality but also need to make a good math on ambience and the lighting features, In order to create a elegant, comfortable and hospitality environment, stand out the personality and image of the hotel.



The office area is engaged in thinking and communication, reacting the office environment and the professional characteristics will affect the working mood and efficiency, lighting environment construction need to conform to the requirements of the person's visual. Pay attention to the diversity of the illumination brightness and chromaticity, provide audiences with a spirited, cheerful fully office environment. At the same time energy saving and environmental protection, in order to reduce energy waste and environment worsening.



According to the apartments lighting have various multi-function environment places, must consider the delicate relationship between whole and the parts, not only need each have distinguishing feature, but also need the overall integration of comfort. using different lighting combinations to create a comfortable bedroom environment, fresh and clear study temperament .distinct corridor and romantic dining atmosphere.



Leisure clubs lighting is not only the perfect combine between the lighting basic elements and the environment, need pay more attention to the construction of environment atmosphere and style of shaping, through using the new elements of controlling the lighting color changes and lighting local strengthening to produce a quietly. warmly, luxurious, simple but elegant and so many other effects on the whole.



The environment of mall is the key to build commercial atmosphere need to Construct the various levels of lighting environment according to the different area function such as window area, exhibition area, new product area image area. fitting area and others places ,Eventually reach the results into consumption. Through the outstanding features, interestof commodity and the comfortable shopping environment.



Outdoor landscape lighting contain the lighting for natural and buildings. The scope Include natural grass and trees, parks, building outline, the hotel, the music field, golf courses, home garden or park avenue, in each place which need to instal lighting to increase Aesthetics, To achieve a bright outdoor lighting at night. At the same time when use the light need to fully consider the use of energy consumption and environmental protection.

Contents

LED Panel Light	02-15
LED Down Light	16-23
LED Spot Light	24-31
LED Lighting Source Series	32-43
LED Strip Light and Spare parts	44-53
LED Outdoor Landscape Light	54-63
LED Wall Light	64-71
LED Emergency Light	72-73
Sensor Light & Intelligent Switch	74-77
LED Track Light	78-81
LED High Bay	82-85
LED Solar Light	86-89
LED Home decor light	90-104
LED Ceiling Fan Lamp	105-107

A 3D rendering of a circular LED panel light. One view shows the smooth, white outer surface, while the other shows the internal components, including a white PCB with orange and blue components, and a white heat sink structure.

LED Panel Light

this kind of products are widely applied to commercial hotel, medical places, household decoration and other lighting places.



Model No: V-PLM1806R	Surface Treatment: WH
Power: SMD 6W	Life Span: 30000H
Input Voltage: AC220-240V 50/60Hz	Material: Alum+PC
Luminous Flux: 480Lm	Working Temperature: -10~45° C
CRI: ≥80	IP: 20
Beam Angle: 120°	Body Size: Φ92*24mm
Color Temperature: 6500/4000/3000K	Hole Size: /



V-PLM1806R

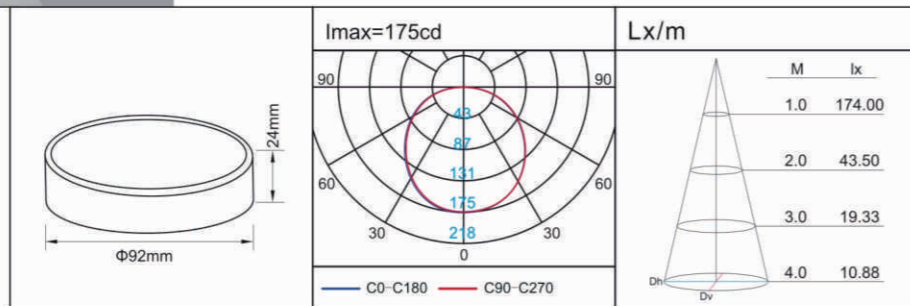

Products list

Model No.	Power	Luminous Flux	Beam angle	Surface	Body Size	Hole Size
V-PLM1806R	SMD 6W	480Lm	120°	WH	Φ92x24mm	/
V-PLM1812R	SMD 12W	960Lm	120°	WH	Φ140x24mm	/
V-PLM1818R	SMD 18W	1500Lm	120°	WH	Φ193x24mm	/

Model No: V-PLM1830R-A	Surface Treatment: WH
Power: SMD 30W	Life Span: 30000H
Input Voltage: AC220-240V 50/60Hz	Material: Alum+PC
Luminous Flux: 3000Lm	Working Temperature: -10~45° C
CRI: ≥80	IP: 20
Beam Angle: 120°	Body Size: Φ220*45mm
Color Temperature: 6500/4000/3000K	Hole Size: /



V-PLM1830R-A

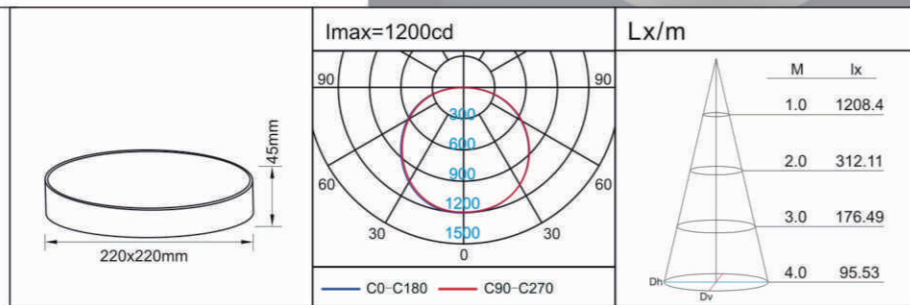

Products list

Model No.	Power	Luminous Flux	Beam angle	Surface	Body Size	Hole Size
V-PLM1830R-A	SMD 30W	3000Lm	120°	WH	Φ220x45mm	/
V-PLM1840R-A	SMD 40W	4000Lm	120°	WH	Φ300x47mm	/



Model No: V-PLQ2630R	Surface Treatment: WH
Power: SMD 30W	Life Span: 25000H
Input Voltage: AC220-240V 50/60Hz	Material: Alum+Glass
Luminous Flux: 2700Lm	Working Temperature: -10~45° C
CRI: ≥75	IP: 20
Beam Angle: 120°	Body Size: Φ225*35mm
Color Temperature: 6500/4000/3000K	Hole Size: Φ200mm



V-PLQ2630R

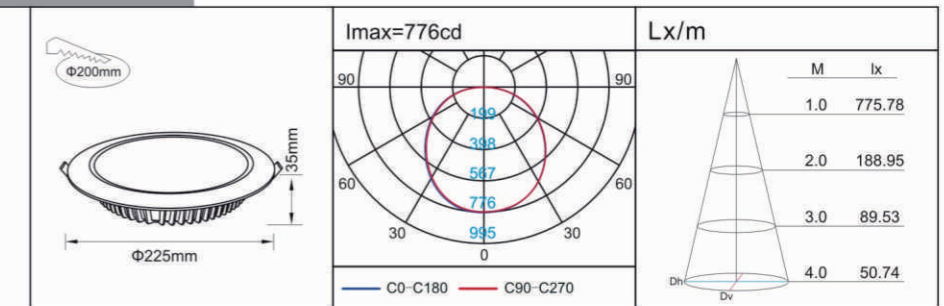

Model No: V-PLM3030R	Surface Treatment: WH
Power: SMD 30W	Life Span: 30000H
Input Voltage: AC220-240V 50/60Hz	Material: Alum+Glass
Luminous Flux: 3000Lm	Working Temperature: -10~45° C
CRI: ≥80	IP: 20
Beam Angle: 120°	Body Size: Φ230*46mm
Color Temperature: 6500/4000/3000K	Hole Size: /



V-PLM3030R

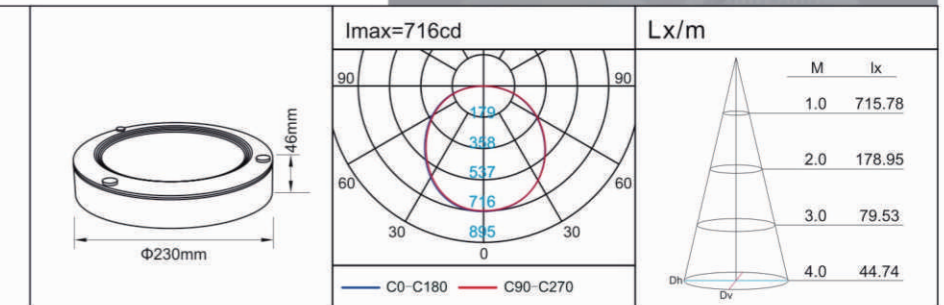

Products list

Model No.	Power	Luminous Flux	Beam angle	Surface	Body Size	Hole Size
V-PLM3030R	SMD 30W	3000Lm	120°	WH	Φ230x46mm	/
V-PLM3040R	SMD 40W	4000Lm	120°	WH	Φ290x46mm	/
MD-PLQ3430R	SMD 30W	2750Lm	120°	WH	Φ220x50mm	Φ190mm



Model No: V-PLQ2912R	Surface Treatment: WH
Power: SMD 15W	Life Span: 30000H
Input Voltage: AC220-240V 50/60Hz	Material: Alum+PC
Luminous Flux: 1300Lm	Working Temperature: -10~45° C
CRI: ≥80	IP: 20
Beam Angle: 120°	Body Size: Φ168*25mm
Color Temperature: 6500/4000/3000K	Hole Size: Φ155mm



V-PLQ2912R

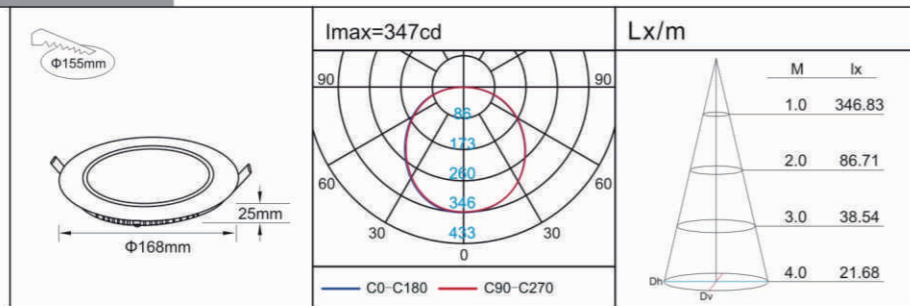

Products list

Model No.	Power	Luminous Flux	Beam angle	Surface	Body Size	Hole Size
V-PLQ2903R	SMD 5W	220Lm	120°	WH	Φ88x25mm	Φ75mm
V-PLQ2906R	SMD 9W	540Lm	120°	WH	Φ117x25mm	Φ105mm
V-PLQ2912R	SMD 15W	1300Lm	120°	WH	Φ168x25mm	Φ155mm
V-PLQ2918R	SMD 24W	1800Lm	120°	WH	Φ222x25mm	Φ210mm

Model No: V-PLM1818S	Surface Treatment: WH
Power: SMD 18W	Life Span: 30000H
Input Voltage: AC220-240V 50/60Hz	Material: Alum+PC
Luminous Flux: 1500Lm	Working Temperature: -10~45° C
CRI: ≥80	IP: 20
Beam Angle: 120°	Body Size: 193*193*24mm
Color Temperature: 6500/4000/3000K	Hole Size: /

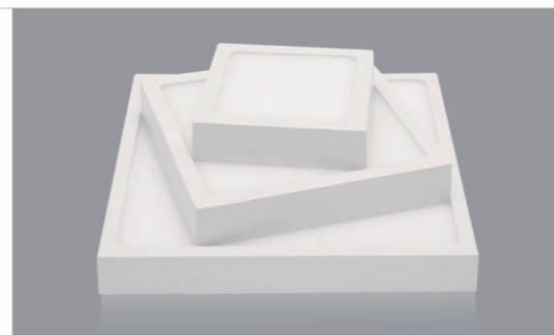

V-PLM1818S

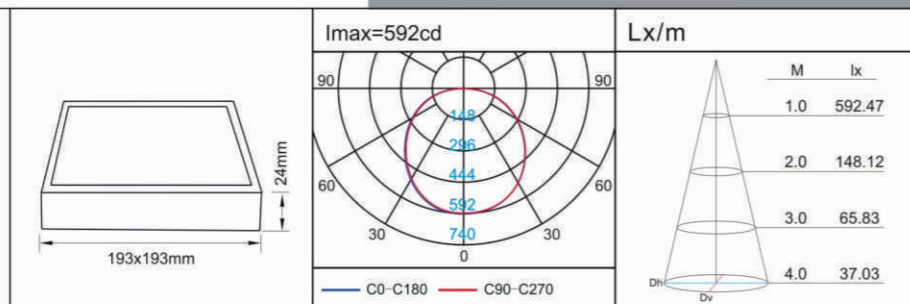

Products list

Model No.	Power	Luminous Flux	Beam angle	Surface	Body Size	Hole Size
V-PLM1806S	SMD 6W	480Lm	120°	WH	92x92x24mm	/
V-PLM1812S	SMD 12W	960Lm	120°	WH	140x140x24mm	/
V-PLM1818S	SMD 18W	1500Lm	120°	WH	193x193x24mm	/



Model No: MD-PLM1920R	Surface Treatment: WH
Power: SMD 20W	Life Span: 25000H
Input Voltage: AC220-240V 50/60Hz	Material: Alum+PC
Luminous Flux: 1400Lm	Working Temperature: -10~45° C
CRI: ≥70	IP: 20
Beam Angle: 120°	Body Size: Φ185*55mm
Color Temperature: 6500/4000/3000K	Hole Size: /



MD-PLM1920R

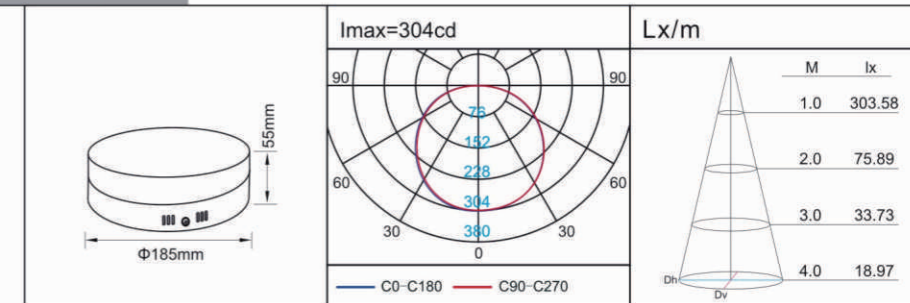

Products list

Model No.	Power	Luminous Flux	Beam angle	Surface	Body Size	Hole Size
MD-PLM1910R	SMD 10W	700Lm	120°	WH	Φ95x55mm	/
MD-PLM1915R	SMD 15W	1050Lm	120°	WH	Φ125x55mm	/
MD-PLM1920R	SMD 20W	1400Lm	120°	WH	Φ185x55mm	/
MD-PLM1930R	SMD 30W	2600Lm	120°	WH	Φ225x55mm	/
MD-PLM1940R	SMD 40W	3500Lm	120°	WH	Φ305x55mm	/

Model No: MD-PLM1940S	Surface Treatment: WH
Power: SMD 40W	Life Span: 25000H
Input Voltage: AC220-240V 50/60Hz	Material: Alum+PC
Luminous Flux: 3500Lm	Working Temperature: -10~45° C
CRI: ≥70	IP: 20
Beam Angle: 120°	Body Size: 305*305*55mm
Color Temperature: 6500/4000/3000K	Hole Size: /



MD-PLM1940S

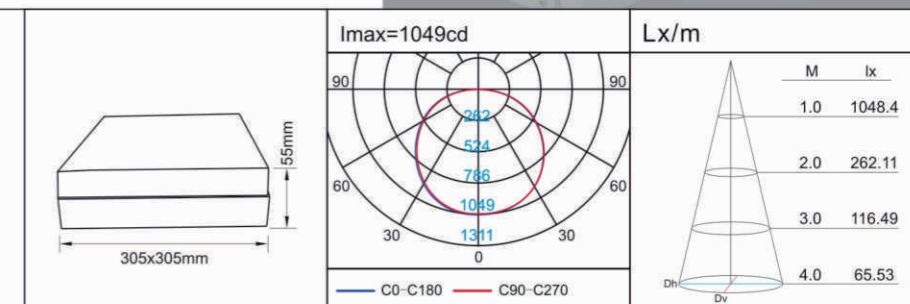

Products list

Model No.	Power	Luminous Flux	Beam angle	Surface	Body Size	Hole Size
MD-PLM1910S	SMD 10W	700Lm	120°	WH	95x91x55mm	/
MD-PLM1915S	SMD 15W	1050Lm	120°	WH	125x121x55mm	/
MD-PLM1920S	SMD 20W	1400Lm	120°	WH	185x181x55mm	/
MD-PLM1930S	SMD 30W	2600Lm	120°	WH	225x221x55mm	/
MD-PLM1940S	SMD 40W	3500Lm	120°	WH	305x305x55mm	/

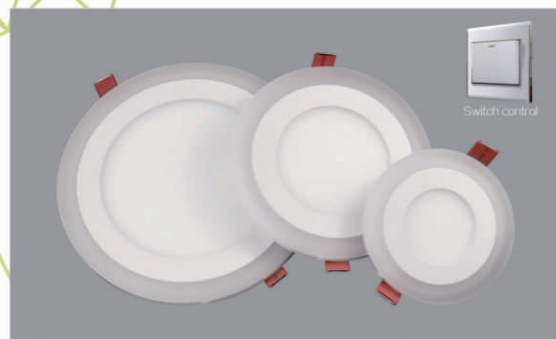

Model No: MD-PLQ1607R	Beam Angle: 120°
Power: SMD 5+2W	Life Span: 25000H
Input Voltage: AC220-240V 50/60Hz	Material: Alum+PC
Luminous Flux: 420Lm	Working Temperature: -10~45° C
CR: ≥80	IP: 20
Color Temperature: 6500/4000/3000K	Body Size: Φ105*33mm
Ring Color: Red/Green/Blue/Pink	Hole Size: Φ85mm

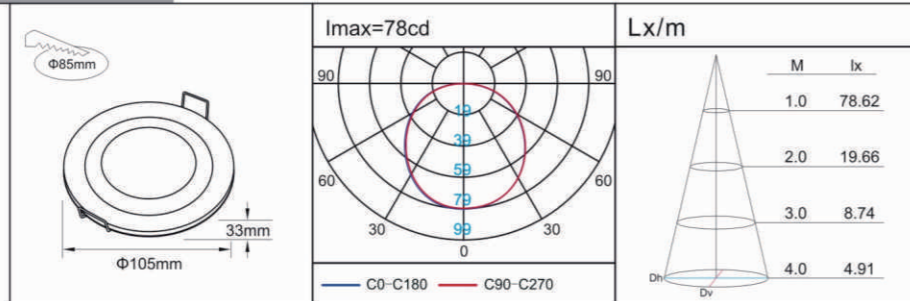

Products list

Model No.	Power	Luminous Flux	Beam angle	Surface	Body Size	Hole Size
MD-PLQ1607R	SMD 5+2W	420Lm	120°	WH	Φ105x33mm	Φ85mm
MD-PLQ1612R	SMD 9+3W	720Lm	120°	WH	Φ145x33mm	Φ115mm
MD-PLQ1618R	SMD 15+3W	1100Lm	120°	WH	Φ190x33mm	Φ170mm
MD-PLQ1624R	SMD 18+6W	1450Lm	120°	WH	Φ240x33mm	Φ215mm

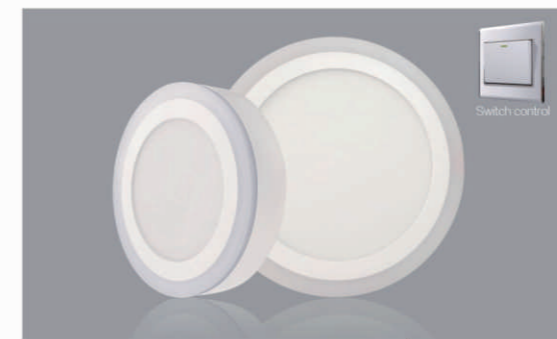

Model No: MD-PLM1607R	Beam Angle: 120°
Power: SMD 5+2W	Surface Treatment: WH
Input Voltage: AC220-240V 50/60Hz	Life Span: 25000H
Luminous Flux: 420Lm	Material: Alum+PC
CR: ≥80	Working Temperature: -10~45° C
Color Temperature: 6500/4000/3000K	IP: 20
Ring Color: Red/Green/Blue/Pink	Body Size: Φ105*35mm

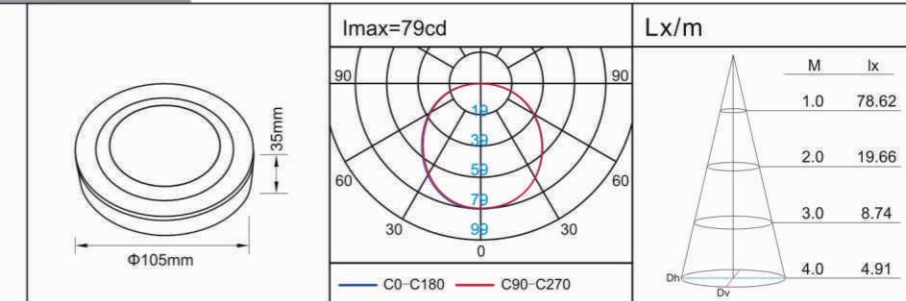

Products list

Model No.	Power	Luminous Flux	Beam angle	Surface	Body Size	Hole Size
MD-PLM1607R	SMD 5+2W	420Lm	120°	WH	Φ105x35mm	/
MD-PLM1612R	SMD 9+3W	720Lm	120°	WH	Φ145x35mm	/
MD-PLM1618R	SMD 15+3W	1100Lm	120°	WH	Φ195x35mm	/
MD-PLM1624R	SMD 18+6W	1450Lm	120°	WH	Φ245x35mm	/

Model No: MD-PLQ1624S	Beam Angle: 120°
Power: SMD 18+6W	Life Span: 25000H
Input Voltage: AC220-240V 50/60Hz	Material: Alum+PC
Luminous Flux: 1450Lm	Working Temperature: -10~45° C
CR: ≥80	IP: 20
Color Temperature: 6500/4000/3000K	Body Size: 240*240*33mm
Ring Color: Red/Green/Blue/Pink	Hole Size: 215*215mm

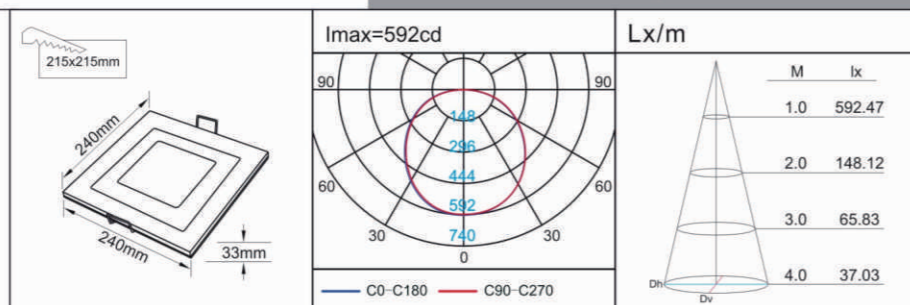
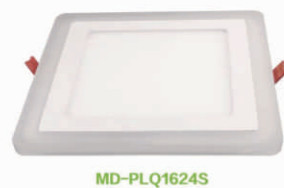
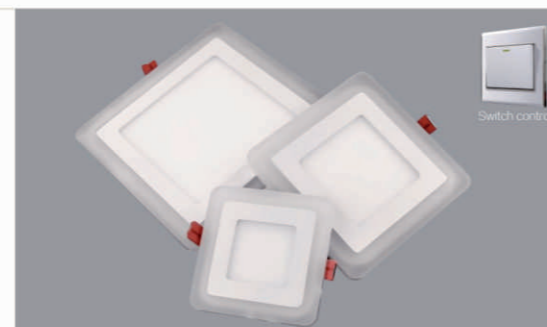

Products list

Model No.	Power	Luminous Flux	Beam angle	Surface	Body Size	Hole Size
MD-PLQ1607S	SMD 5+2W	420Lm	120°	WH	105x105x33mm	85x85mm
MD-PLQ1612S	SMD 9+3W	720Lm	120°	WH	145x145x33mm	115x115mm
MD-PLQ1618S	SMD 15+3W	1100Lm	120°	WH	190x190x33mm	170x170mm
MD-PLQ1624S	SMD 18+6W	1450Lm	120°	WH	240x240x33mm	215x215mm

Model No: MD-PLM1624S	Beam Angle: 120°
Power: SMD 18+6W	Surface Treatment: WH
Input Voltage: AC220-240V 50/60Hz	Life Span: 25000H
Luminous Flux: 1450Lm	Material: Alum+PC
CR: ≥80	Working Temperature: -10~45° C
Color Temperature: 6500/4000/3000K	IP: 20
Ring Color: Red/Green/Blue/Pink	Body Size: 245*245*35mm

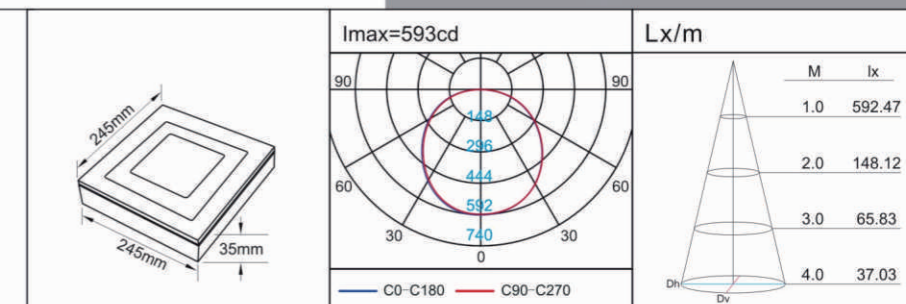
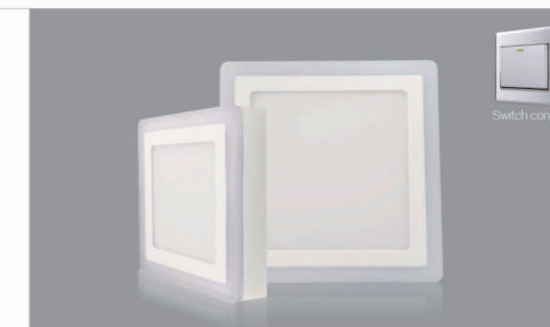

Products list

Model No.	Power	Luminous Flux	Beam angle	Surface	Body Size	Hole Size
MD-PLM1607S	SMD 5+2W	420Lm	120°	WH	105x105x35mm	/
MD-PLM1612S	SMD 9+3W	720Lm	120°	WH	145x145x35mm	/
MD-PLM1618S	SMD 15+3W	1100Lm	120°	WH	195x195x35mm	/
MD-PLM1624S	SMD 18+6W	1450Lm	120°	WH	245x245x35mm	/



Model No: MD-15193	Surface Treatment: WH
Power: SMD 18W	Life Span: 25000H
Input Voltage: AC220-240V 50/60Hz	Material: Alum+PC
Luminous Flux: 1450Lm	Working Temperature: -10~45° C
CRI: ≥70	IP: 20
Beam Angle: 120°	Body Size: Φ170*20mm
Color Temperature: 6500/4000/3000K	Hole Size: Φ160mm



MD-15193

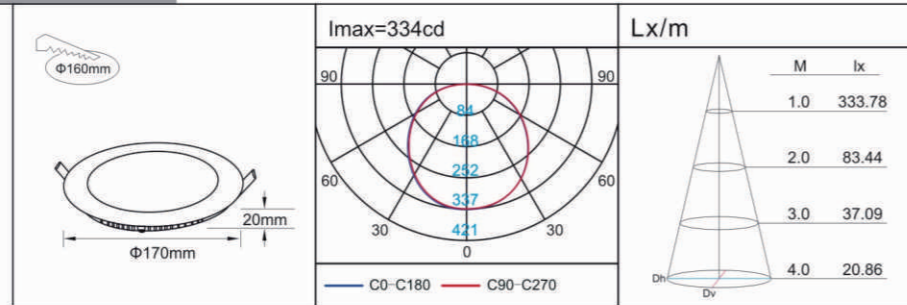

Products list

Model No.	Power	Luminous Flux	Beam angle	Surface	Body Size	Hole Size
MD-15191	SMD 5W	350Lm	120°	WH	Φ90x20mm	Φ75mm
MD-15198	SMD 9W	630Lm	120°	WH	Φ123x20mm	Φ110mm
MD-151910	SMD 12W	960Lm	120°	WH	Φ148x20mm	Φ135mm
MD-15193	SMD 18W	1450Lm	120°	WH	Φ170x20mm	Φ160mm
MD-15194	SMD 24W	1920Lm	120°	WH	Φ225x20mm	Φ210mm
MD-15197	SMD 30W	2400Lm	120°	WH	Φ300x20mm	Φ285mm



MD-151912

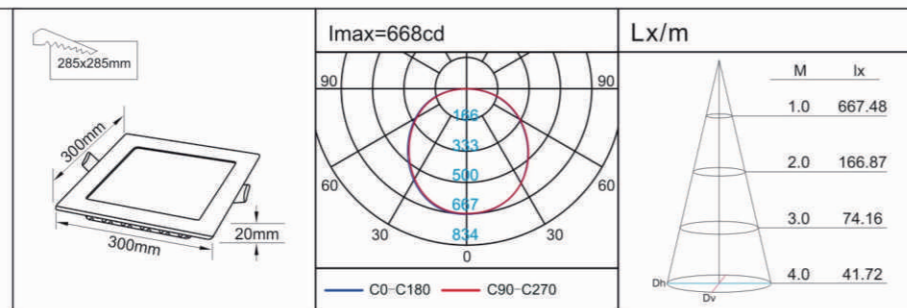

Products list

Model No.	Power	Luminous Flux	Beam angle	Surface	Body Size	Hole Size
MD-15192	SMD 5W	350Lm	120°	WH	90x90x20mm	75x75mm
MD-15199	SMD 9W	630Lm	120°	WH	123x123x20mm	110x110mm
MD-151911	SMD 12W	960Lm	120°	WH	148x148x20mm	135x135mm
MD-15195	SMD 18W	1450Lm	120°	WH	175x175x20mm	160x160mm
MD-15196	SMD 24W	1920Lm	120°	WH	225x225x20mm	210x210mm
MD-151912	SMD 30W	2400Lm	120°	WH	300x300x20mm	285x285mm



Model No: MD-15197-MZ	Surface Treatment: WH
Power: SMD 30W	Life Span: 25000H
Input Voltage: AC220-240V 50/60Hz	Material: Alum+PC
Luminous Flux: 2400Lm	Working Temperature: -10~45° C
CRI: ≥70	IP: 20
Beam Angle: 120°	Body Size: Φ300*36mm
Color Temperature: 6500/4000/3000K	Hole Size: /



MD-15197-MZ

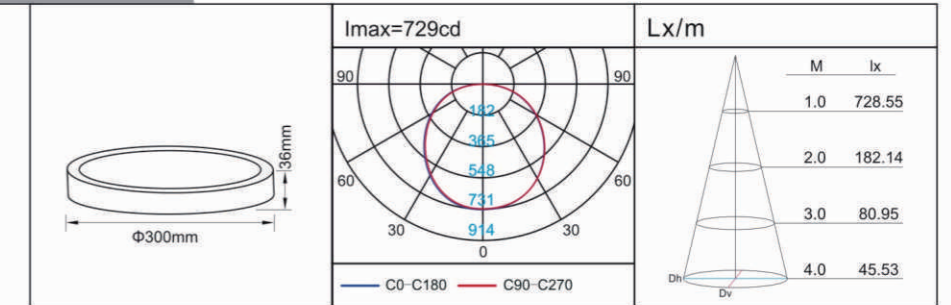

Products list

Model No.	Power	Luminous Flux	Beam angle	Surface	Body Size	Hole Size
MD-15198-MZ	SMD 9W	630Lm	120°	WH	Φ123x36mm	/
MD-15193-MZ	SMD 18W	1450Lm	120°	WH	Φ170x36mm	/
MD-15194-MZ	SMD 24W	1920Lm	120°	WH	Φ225x36mm	/
MD-15197-MZ	SMD 30W	2400Lm	120°	WH	Φ300x36mm	/



MD-151912-MZ

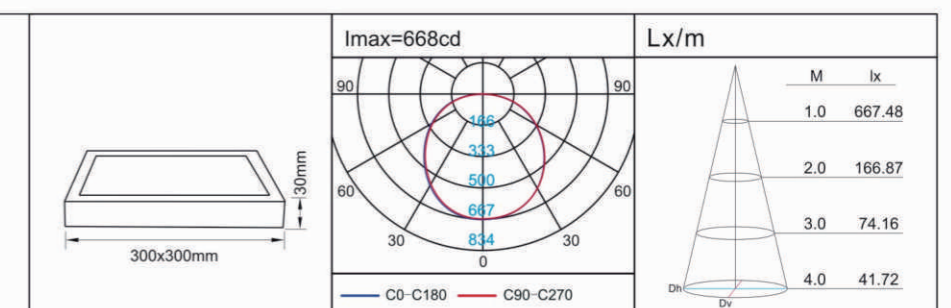

Products list

Model No.	Power	Luminous Flux	Beam angle	Surface	Body Size	Hole Size
MD-15199-MZ	SMD 9W	630Lm	120°	WH	123x123x36mm	/
MD-15195-MZ	SMD 18W	1450Lm	120°	WH	170x170x36mm	/
MD-15196-MZ	SMD 24W	1920Lm	120°	WH	225x225x36mm	/
MD-151912-MZ	SMD 30W	2400Lm	120°	WH	300x300x36mm	/



Model No: MD-0112A	Surface Treatment: WH
Power: SMD 12W	Life Span: 25000H
Input Voltage: AC220-240V 50/60Hz	Material: Alum+Glass
Luminous Flux: 900Lm	Working Temperature: -10~45° C
CRi: ≥70	IP: 20
Beam Angle: 120°	Body Size: Φ160*37mm
Color Temperature: 3 color	Hole Size: Φ125mm

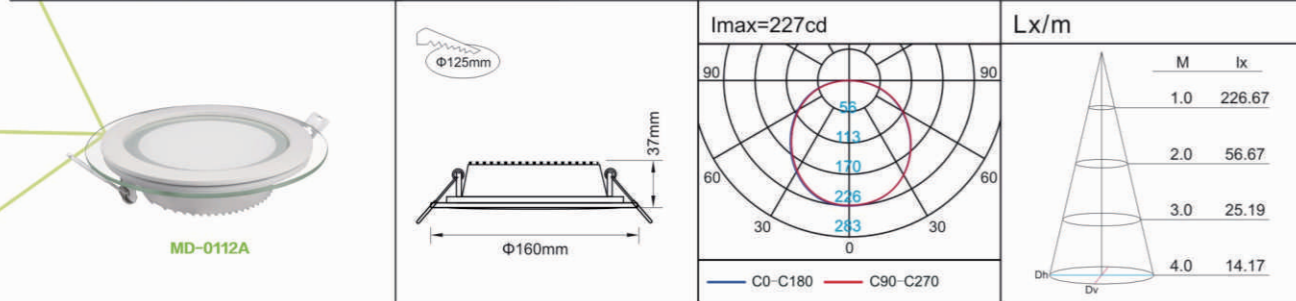

Products list

Model No.	Power	Luminous Flux	Beam angle	Surface	Body Size	Hole Size
MD-0108A	SMD 8W	600Lm	120°	WH	Φ98x35mm	Φ75mm
MD-0112A	SMD 12W	900Lm	120°	WH	Φ160x37mm	Φ125mm
MD-0118A	SMD 18W	1500Lm	120°	WH	Φ200x35mm	Φ167mm



Model No: MD-0115B	Surface Treatment: WH
Power: SMD 15W	Life Span: 25000H
Input Voltage: AC220-240V 50/60Hz	Material: Alum+Glass
Luminous Flux: 900Lm	Working Temperature: -10~45° C
CRi: ≥70	IP: 20
Beam Angle: 120°	Body Size: Φ160*35mm
Color Temperature: 6500/4000/3000K	Hole Size: Φ125mm

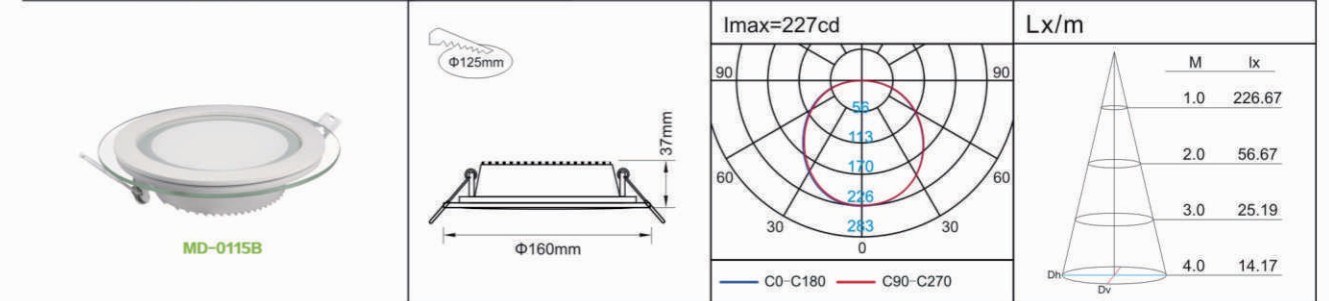

Products list

Model No.	Power	Luminous Flux	Beam angle	Surface	Body Size	Hole Size
MD-0110B	SMD 8W	600Lm	120°	WH	Φ98x35mm	Φ75mm
MD-0115B	SMD 15W	900Lm	120°	WH	Φ160x35mm	Φ125mm
MD-0120B	SMD 20W	1500Lm	120°	WH	Φ200x35mm	Φ167mm

Model No: MD-0218A	Surface Treatment: WH
Power: SMD 18W	Life Span: 25000H
Input Voltage: AC220-240V 50/60Hz	Material: Alum+Glass
Luminous Flux: 1500Lm	Working Temperature: -10~45° C
CRi: ≥70	IP: 20
Beam Angle: 120°	Body Size: 200*200*42mm
Color Temperature: 3 color	Hole Size: 170*170mm

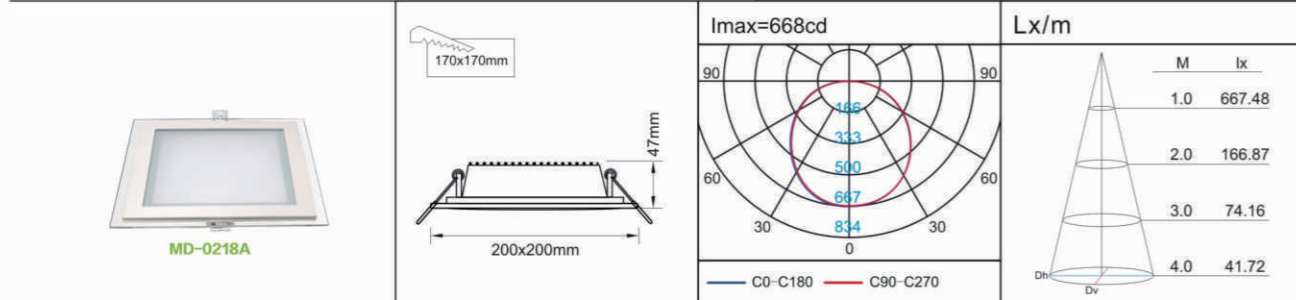

Products list

Model No.	Power	Luminous Flux	Beam angle	Surface	Body Size	Hole Size
MD-0208A	SMD 8W	600Lm	120°	WH	98x98x35mm	75x75mm
MD-0212A	SMD 12W	900Lm	120°	WH	160x160x37mm	125x125mm
MD-0218A	SMD 18W	1500Lm	120°	WH	200x200x35mm	170x170mm

Model No: MD-0220B	Surface Treatment: WH
Power: SMD 20W	Life Span: 25000H
Input Voltage: AC220-240V 50/60Hz	Material: Alum+Glass
Luminous Flux: 1500Lm	Working Temperature: -10~45° C
CRi: ≥70	IP: 20
Beam Angle: 120°	Body Size: 200*200*35mm
Color Temperature: 6500/4000/3000K	Hole Size: 170*170mm

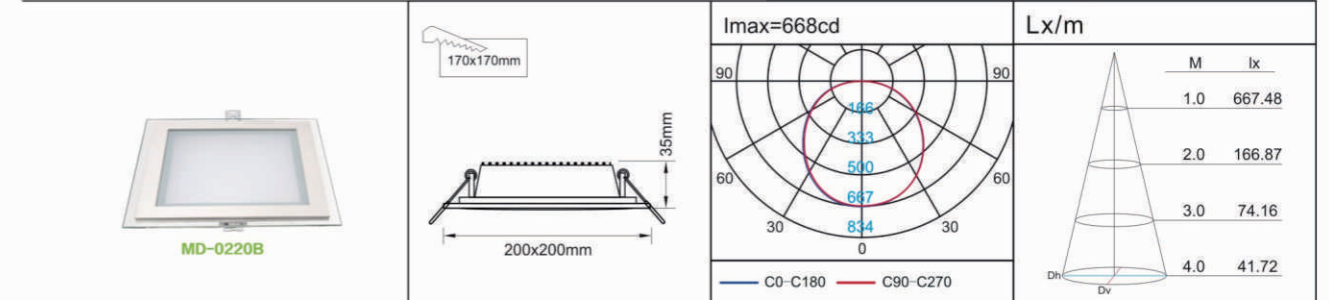

Products list

Model No.	Power	Luminous Flux	Beam angle	Surface	Body Size	Hole Size
MD-0210B	SMD 8W	600Lm	120°	WH	98x98x35mm	90x90mm
MD-0215B	SMD 15W	900Lm	120°	WH	160x160x35mm	125x125mm
MD-0220B	SMD 20W	1500Lm	120°	WH	200x200x35mm	170x170mm



Model No: V-LDQ0196S	Surface Treatment: WH
Power: SMD 96W	Life Span: 30000H
Input Voltage: AC220-240V 50/60Hz	Material: Alum+PC
Luminous Flux: 9600Lm	Working Temperature: -10~45° C
CRt: ≥80	IP: 20
Beam Angle: 120°	Body Size: 595*595*28mm
Color Temperature: 6500/4000/3000K	Hole Size: 575*575mm

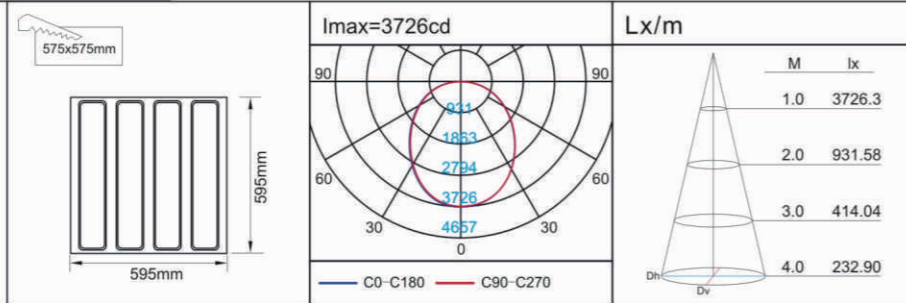

V-LDQ0196S

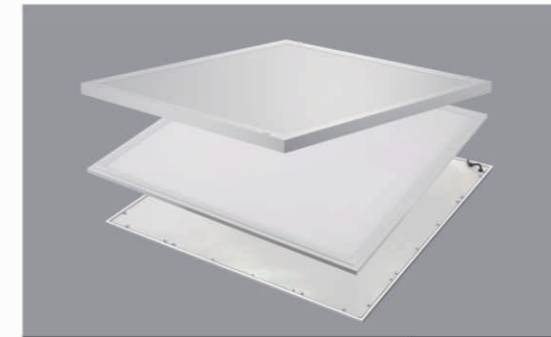

Model No: V-126060-60	Surface Treatment: WH/SL
Power: SMD 60W	Life Span: 30000H
Input Voltage: AC220-240V 50/60Hz	Material: Alum+PC
Luminous Flux: 5400Lm	Working Temperature: -10~45° C
CRt: ≥80	IP: 20
Beam Angle: 120°	Body Size: 595*595*8mm
Color Temperature: 6500/4000/3000K	Hole Size: /

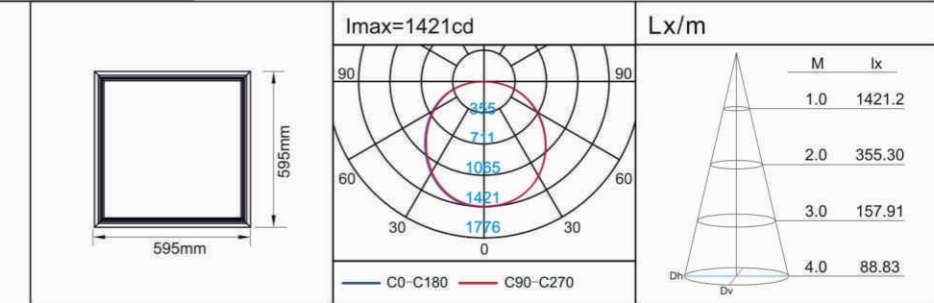

V-126060-60

Products list

Model No.	Power	Luminous Flux	Beam angle	Surface	Body Size	Hole Size
V-126060-60	SMD 60W	5400Lm	120°	WH	595x595x8mm	/
V-126060A-MZ	SMD 60W	5600Lm	120°	WH	595x595x8mm	/

Model No: MD-LDM0196S	Surface Treatment: WH
Power: SMD 96W	Life Span: 25000H
Input Voltage: AC220-240V 50/60Hz	Material: Alum+PC
Luminous Flux: 8000Lm	Working Temperature: -10~45° C
CRt: ≥70	IP: 20
Beam Angle: 120°	Body Size: 595*595*31mm
Color Temperature: 6500/4000/3000K	Hole Size: /

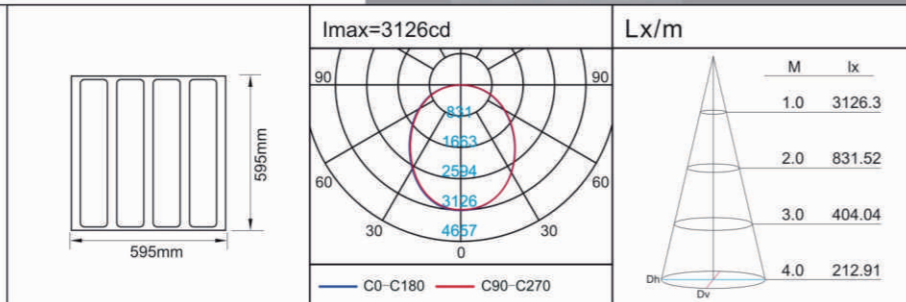

MD-LDM0196S

Products list

Model No.	Power	Luminous Flux	Beam angle	Surface	Body Size	Hole Size
V-LDQ0196S	SMD 96W	9600Lm	120°	WH	595x595x28mm	575x575mm
MD-LDQ0196S	SMD 96W	8000Lm	120°	WH	595x595x28mm	575x575mm
MD-LDM0196S	SMD 96W	8000Lm	120°	WH	595x595x31mm	/
MD-LDJ0196S	SMD 96W	8000Lm	120°	WH	598x598x29mm	/

Model No: MD-126060-40	Surface Treatment: WH/SL
Power: SMD 40W	Life Span: 25000H
Input Voltage: AC220-240V 50/60Hz	Material: Alum+PC
Luminous Flux: 3600Lm	Working Temperature: -10~45° C
CRt: ≥80	IP: 20
Beam Angle: 120°	Body Size: 595*595*8mm
Color Temperature: 6500/4000/3000K	Hole Size: /

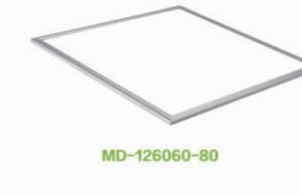
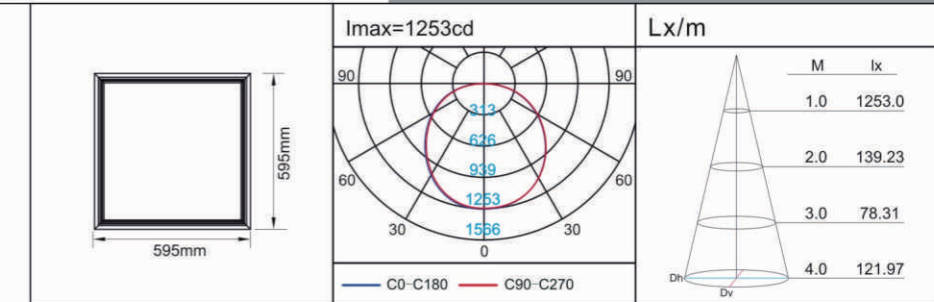
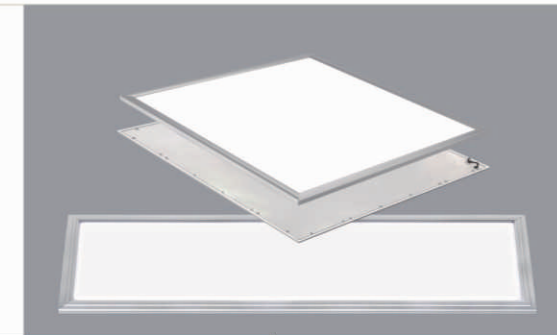

MD-126060-40

Products list

Model No.	Power	Luminous Flux	Beam angle	Surface	Body Size	Hole Size
MD-126060-40	SMD 40W	3600Lm	120°	WH	595x595x8mm	/
MD-126060-60	SMD 60W	5800Lm	120°	WH	595x595x8mm	/
MD-126060-60 JC	SMD 60W	5800Lm	120°	WH	600x600x15mm	/
MD-126060-80	SMD 80W	7000Lm	120°	WH	595x595x8mm	/
MD-1230120-60	SMD 60W	5200Lm	120°	WH	1195x297x9mm	/

V.MAX[®] LED Pendant Light



Model No: MD-SD13250L	Surface Treatment: WH/BK
Power: SMD 48W	Life Span: 25000H
Input Voltage: AC220-240V 50/60Hz	Material: Alum+PC
Luminous Flux: 4500Lm	Working Temperature: -10~45° C
CR: ≥75	IP: 20
Beam Angle: 120°	Body Size: 1200*200*65mm
Color Temperature: 6500/4000/3000K	Hole Size: /



MD-SD13250L

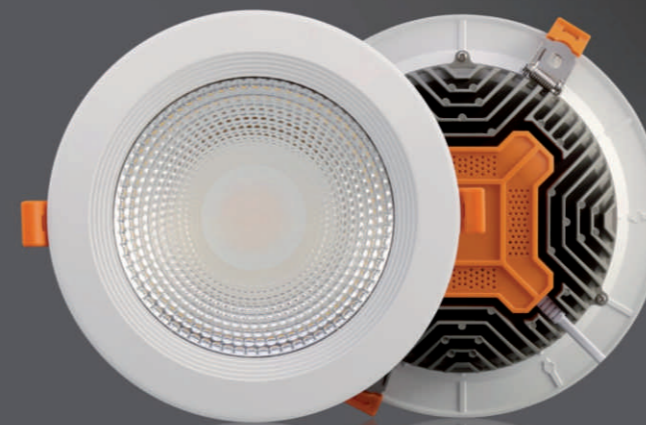
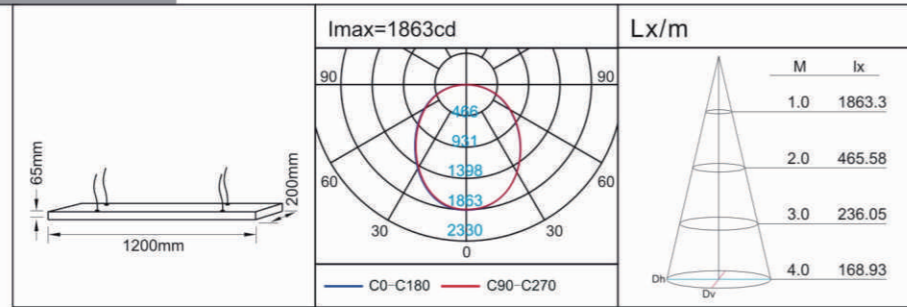

LED Down Light

this kind of products are widely applied to large office, conference room, department stores, specialty stores, lab, airports and other places.



Model No: V-DLQ3730R	Surface Treatment: WH
Power: COB 30W	Life Span: 30000H
Input Voltage: AC220-240V 50/60Hz	Material: Alum+Glass+PC
Luminous Flux: 2700Lm	Working Temperature: -10~45° C
CRI: ≥80	IP: 20
Beam Angle: 105°	Body Size: Φ225*78mm
Color Temperature: 6500/4000/3000K	Hole Size: Φ200mm



V-DLQ3730R

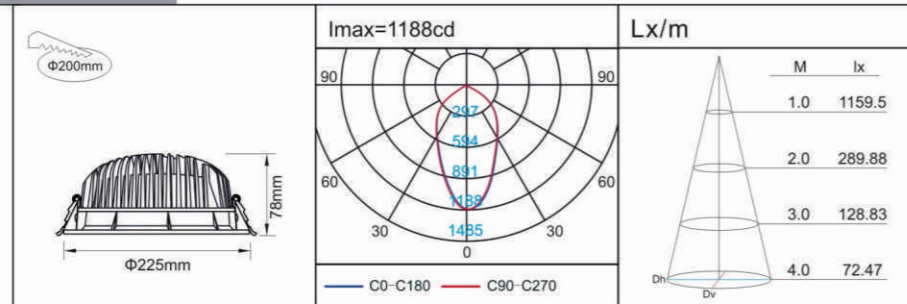

Products list

Model No.	Power	Luminous Flux	Beam angle	Surface	Body Size	Hole Size
V-DLQ3710R-A	COB 10W	800Lm	100°	WH	Φ131x67mm	Φ110mm
V-DLQ3715R	COB 15W	1450Lm	105°	WH	Φ167x74mm	Φ145mm
V-DLQ3720R	COB 20W	1900Lm	105°	WH	Φ195x76mm	Φ170mm
V-DLQ3730R	COB 30W	2700Lm	105°	WH	Φ225x78mm	Φ200mm

Model No: V-DLQ4115R	Surface Treatment: WH
Power: SMD 15W	Life Span: 30000H
Input Voltage: AC220-240V 50/60Hz	Material: Alum+PC
Luminous Flux: 1050Lm	Working Temperature: -10~45° C
CRI: ≥80	IP: 20
Beam Angle: 120°	Body Size: Φ112*40mm
Color Temperature: 6500/4000/3000K	Hole Size: Φ100mm



V-DLQ4115R

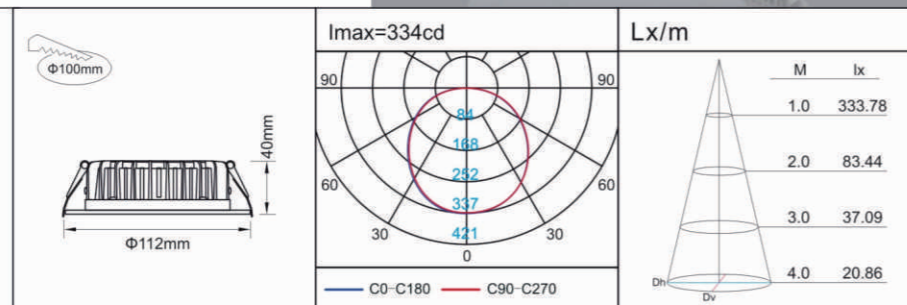

Products list

Model No.	Power	Luminous Flux	Beam angle	Surface	Body Size	Hole Size
V-DLQ4115R	SMD 15W	1050Lm	120°	WH	Φ112x40mm	Φ100mm
V-DLQ4120R	SMD 20W	1650Lm	120°	WH	Φ165x43mm	Φ150mm
V-DLQ4125R	SMD 25W	2000Lm	120°	WH	Φ188x45mm	Φ165mm
V-DLQ4140R	SMD 40W	4000Lm	120°	WH	Φ227x47mm	Φ205mm

Smart Down Light



Model No: V-DLQ0820RY	Surface Treatment: WH
Power: SMD 20W	Life Span: 30000H
Input Voltage: AC220-240V 50/60Hz	Material: Alum+PC
Luminous Flux: 1600Lm	Working Temperature: -10~45° C
CRI: ≥80	IP: 20
Beam Angle: 120°	Body Size: Φ181*105mm
Color Temperature: 3000-6500K+Night Light	Hole Size: Φ155mm



V-DLQ0820RY

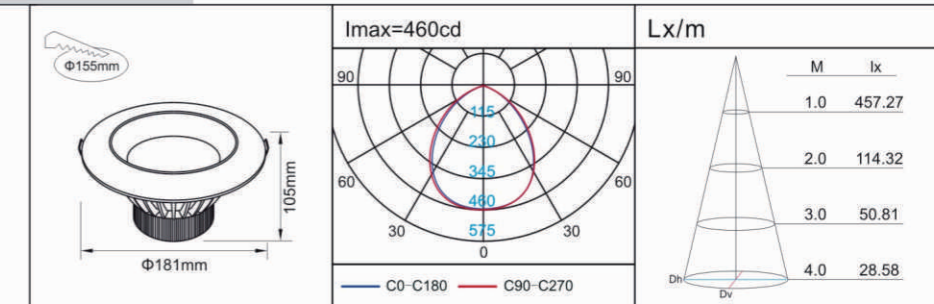

Products list

Model No.	Power	Luminous Flux	Beam angle	Surface	Body Size	Hole Size
V-DLQ0808RY	SMD 8W	550Lm	120°	WH	Φ103x78mm	Φ85mm
V-DLQ0812RY	SMD 12W	850Lm	120°	WH	Φ120x87mm	Φ100mm
V-DLQ0815RY	SMD 15W	1200Lm	120°	WH	Φ159x101mm	Φ140mm
V-DLQ0820RY	SMD 20W	1600Lm	120°	WH	Φ181x105mm	Φ155mm

Model No: V-DLQ4780R	Surface Treatment: WH
Power: SMD 80W	Life Span: 30000H
Input Voltage: AC220-240V 50/60Hz	Material: Alum+PC
Luminous Flux: 7200Lm	Working Temperature: -10~45° C
CRI: ≥85	IP: 20
Beam Angle: 90°	Body Size: Φ230*128mm
Color Temperature: 6500/4000/3000K	Hole Size: Φ210mm



V-DLQ4780R

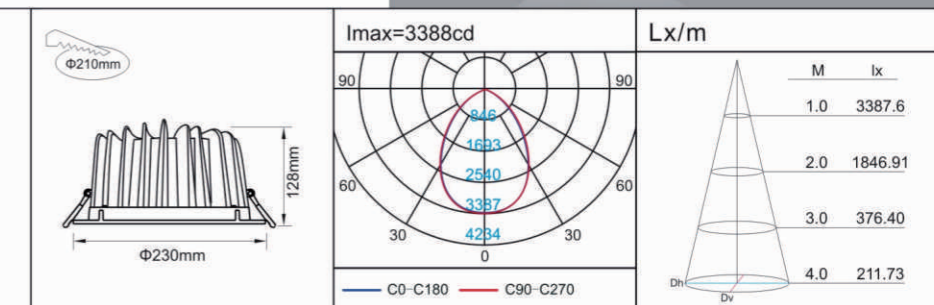



Model No: V-DLQ2260R	Surface Treatment: WH
Power: COB 60W	Life Span: 30000H
Input Voltage: AC220-240V 50/60Hz	Material: Alum+Glass+PC
Luminous Flux: 5700Lm	Working Temperature: -10-45° C
CRt: ≥85	IP: 20
Beam Angle: 70°	Body Size: Φ230*110mm
Color Temperature: 6500/4000/3000K	Hole Size: Φ215mm



V-DLQ2260R

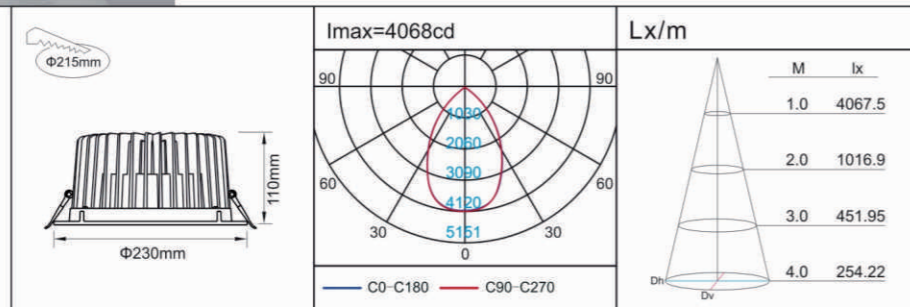

Products list

Model No.	Power	Luminous Flux	Beam angle	Surface	Body Size	Hole Size
V-DLQ2260R	COB 60W	5700Lm	70°	WH	Φ230x110mm	Φ215mm
V-DLQ2260S	COB 60W	5700Lm	70°	WH	230x230x110mm	Φ215mm

Model No: V-DLQ2280R	Surface Treatment: WH
Power: COB 80W	Life Span: 30000H
Input Voltage: AC220-240V 50/60Hz	Material: Alum+Glass+PC
Luminous Flux: 7000Lm	Working Temperature: -10-45° C
CRt: ≥85	IP: 20
Beam Angle: 60°	Body Size: Φ225*120mm
Color Temperature: 6500/4000/3000K	Hole Size: Φ200mm



V-DLQ2280R

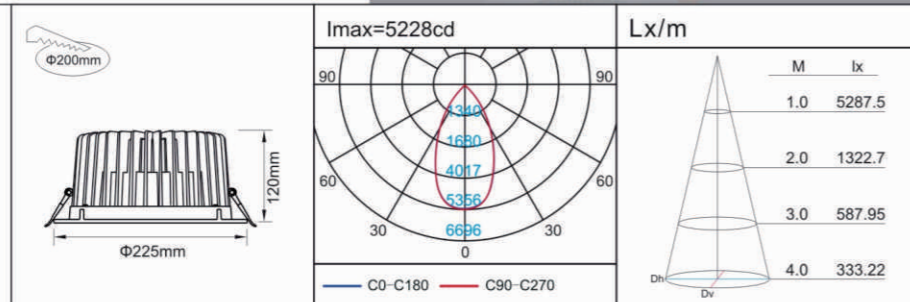

Model No: MD-DLQ2250R	Surface Treatment: WH
Power: COB 50W	Life Span: 25000H
Input Voltage: AC220-240V 50/60Hz	Material: Alum+PC
Luminous Flux: 4800Lm	Working Temperature: -10-45° C
CRt: ≥85	IP: 20
Beam Angle: 38°	Body Size: Φ230*103mm
Color Temperature: 6500/4000/3000K	Hole Size: Φ215mm



MD-DLQ2250R

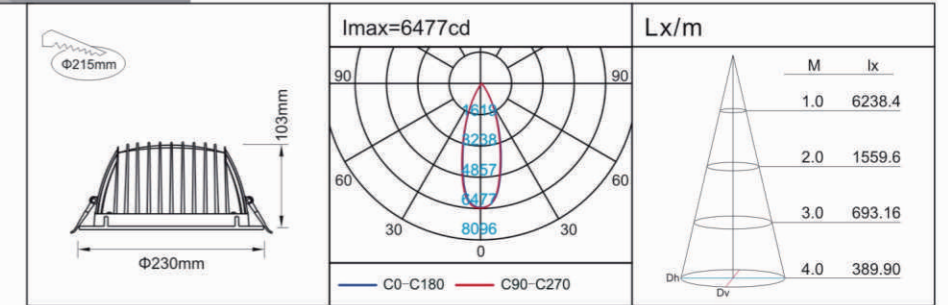

Products list

Model No.	Power	Luminous Flux	Beam angle	Surface	Body Size	Hole Size
MD-DLQ2250R	COB 50W	4800Lm	38°	WH	Φ230x103mm	Φ215mm
MD-DLQ2250S	COB 50W	4800Lm	38°	WH	230x230x103mm	Φ215mm



Model No: MD-DLQ3860R	Surface Treatment: WH
Power: COB 60W	Life Span: 25000H
Input Voltage: AC220-240V 50/60Hz	Material: Alum+Glass
Luminous Flux: 4800Lm	Working Temperature: -10-45° C
CRt: ≥85	IP: 20
Beam Angle: 38°	Body Size: Φ230*117mm
Color Temperature: 6500/4000/3000K	Hole Size: Φ205mm



MD-DLQ3860R

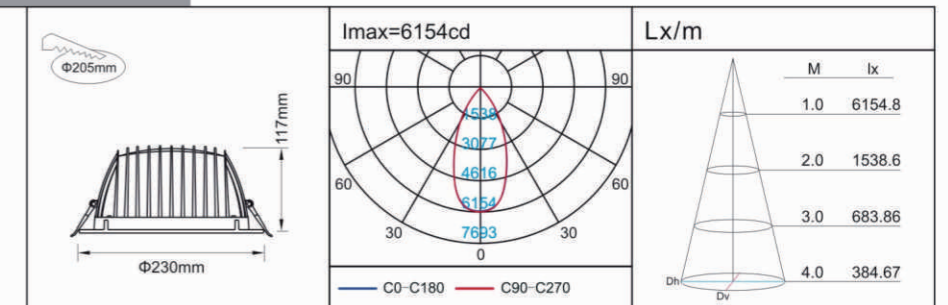

Products list

Model No.	Power	Luminous Flux	Beam angle	Surface	Body Size	Hole Size
MD-DLQ3812R	COB 12W	960Lm	38°	WH	Φ120x65mm	Φ105mm
MD-DLQ3830R	COB 30W	2400Lm	38°	WH	Φ175x80mm	Φ150mm
MD-DLQ3860R	COB 60W	4800Lm	38°	WH	Φ230x117mm	Φ205mm



Model No: MD-C1930	Surface Treatment: WH/SN
Power: COB 30W	Life Span: 30000H
Input Voltage: AC220-240V 50/60Hz	Material: Alum+Glass+PC
Luminous Flux: 2400Lm	Working Temperature: -10~45° C
CRI: ≥80	IP: 20
Beam Angle: 145°	Body Size: Φ223*80mm
Color Temperature: 6500/4000/3000K	Hole Size: Φ200mm



MD-C1930

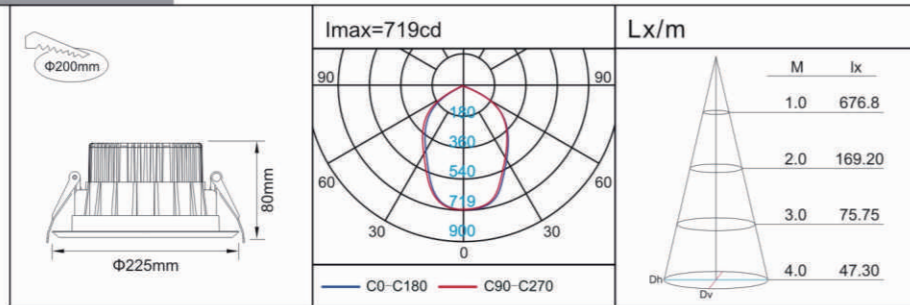

Products list

Model No.	Power	Luminous Flux	Beam angle	Surface	Body Size	Hole Size
MD-C1910	COB 10W	800Lm	120°	WH/SN	Φ135x70mm	Φ110mm
MD-C1915	COB 15W	1200Lm	145°	WH/SN	Φ175x75mm	Φ155mm
MD-C1920	COB 20W	1600Lm	145°	WH/SN	Φ195x80mm	Φ175mm
MD-C1930	COB 30W	2400Lm	145°	WH/SN	Φ225x80mm	Φ200mm



MD-DLM3430R

Model No: MD-DLM3430R	Surface Treatment: WH
Power: COB 30W	Life Span: 25000H
Input Voltage: AC220-240V 50/60Hz	Material: Alum+Glass
Luminous Flux: 2400Lm	Working Temperature: -10~45° C
CRI: ≥70	IP: 20
Beam Angle: 100°	Body Size: Φ220*41mm
Color Temperature: 6500/4000/3000K	Hole Size: /

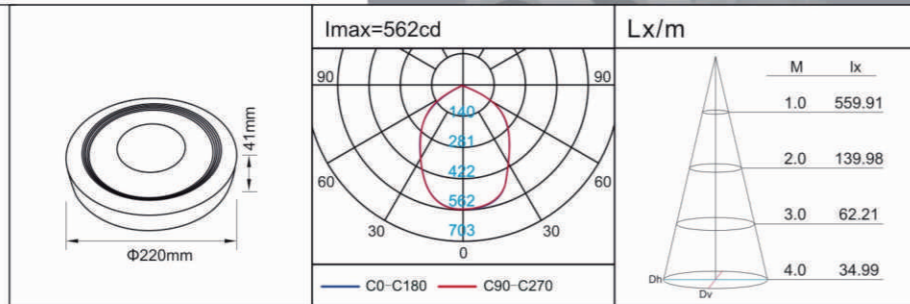
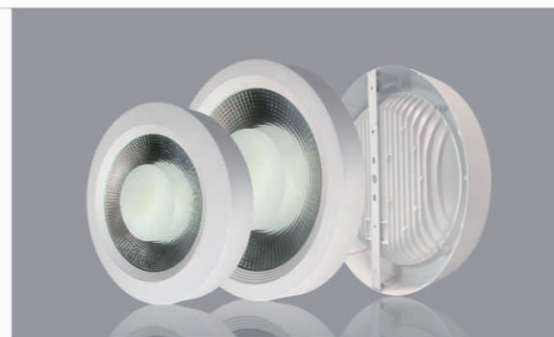

Products list

Model No.	Power	Luminous Flux	Beam angle	Surface	Body Size	Hole Size
MD-DLM3430R	COB 30W	2400Lm	100°	WH	Φ220x41mm	/
MD-DLM3440R	COB 40W	3200Lm	100°	WH	Φ300x50mm	/



Model No: MD-DLQ7005R	Surface Treatment: WH
Power: SMD 5W	Life Span: 25000H
Input Voltage: AC220-240V 50/60Hz	Material: Alum+PC
Luminous Flux: 400Lm	Working Temperature: -10~45° C
CRI: ≥80	IP: 20
Beam Angle: 120°	Body Size: Φ100*35mm
Color Temperature: 6500/4000/3000K	Hole Size: Φ75mm



MD-DLQ7005R

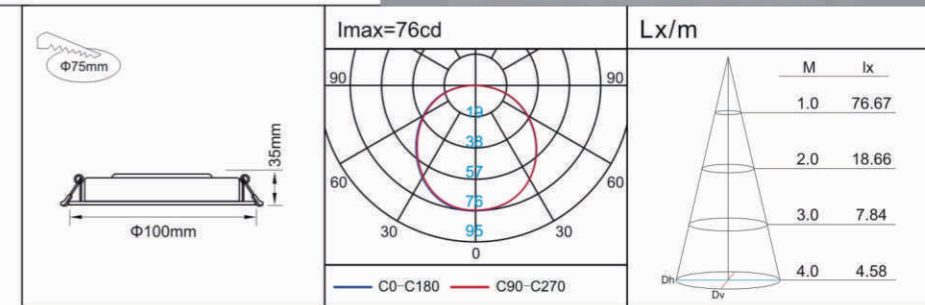

Products list

Model No.	Power	Luminous Flux	Beam angle	Surface	Body Size	Hole Size
MD-DLQ7005R	SMD 5W	400Lm	120°	WH	Φ100x35mm	Φ75mm
MD-DLQ7007R	SMD 7W	510Lm	120°	WH	Φ115x35mm	Φ85mm
MD-DLQ7012R	SMD 12W	1000Lm	120°	WH	Φ152x35mm	Φ120mm
MD-DLQ7018R	SMD 18W	1450Lm	120°	WH	Φ185x35mm	Φ155mm
MD-DLQ7025R	SMD 25W	2300Lm	120°	WH	Φ225x58mm	Φ195mm



V.MAX[®] LED Down Light



Model No: MD-DLQ2010R	Surface Treatment: WH/SN
Power: COB 10W	Life Span: 25000H
Input Voltage: AC220-240V 50/60Hz	Material: Alum+Glass+PC
Luminous Flux: 800Lm	Working Temperature: -10~45° C
CRi: ≥70	IP: 20
Beam Angle: 120°	Body Size: Φ124*36mm
Color Temperature: 6500/4000/3000K	Hole Size: Φ110mm



MD-DLQ2010R

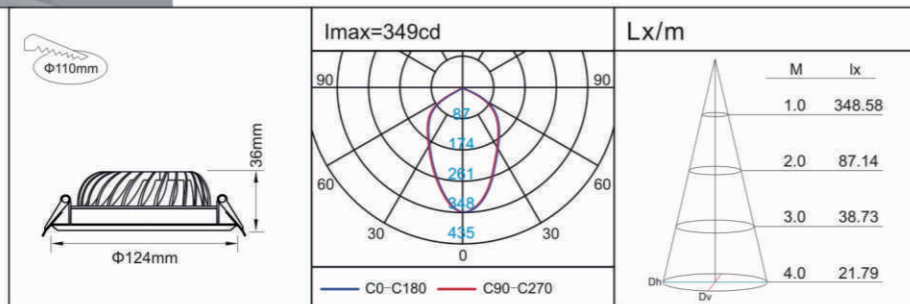

Products list

Model No.	Power	Luminous Flux	Beam angle	Surface	Body Size	Hole Size
MD-DLQ2010R	COB 10W	800Lm	120°	WH/SN	Φ124x36mm	Φ110mm
MD-DLQ2015R	COB 15W	1200Lm	120°	WH/SN	Φ165x41mm	Φ140mm
MD-DLQ2020R	COB 20W	1600Lm	120°	WH/SN	Φ187x48mm	Φ170mm
MD-DLQ2030R	COB 30W	2400Lm	120°	WH/SN	Φ227x61mm	Φ205mm

Model No: MD-DLQ6206R	Surface Treatment: WH
Power: SMD 6W	Life Span: 25000H
Input Voltage: AC220-240V 50/60Hz	Material: Alum+PC
Luminous Flux: 420Lm	Working Temperature: -10~45° C
CRi: ≥70	IP: 50
Beam Angle: 120°	Body Size: Φ98*42mm
Color Temperature: 6500/4000/3000K	Hole Size: Φ80mm

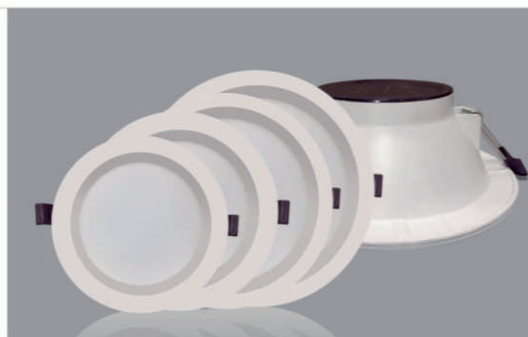

MD-DLQ6206R

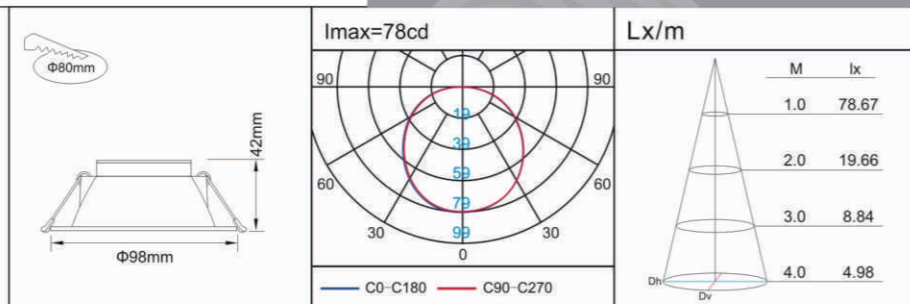

Products list

Model No.	Power	Luminous Flux	Beam angle	Surface	Body Size	Hole Size
MD-DLQ6206R	SMD 6W	420Lm	120°	WH	Φ98x42mm	Φ80mm
MD-DLQ6209R	SMD 9W	630Lm	120°	WH	Φ121x49mm	Φ95mm
MD-DLQ6212R	SMD 12W	840Lm	120°	WH	Φ147x55mm	Φ120mm
MD-DLQ6218R	SMD 18W	1260Lm	120°	WH	Φ177x58mm	Φ150mm
MD-DLQ6224R	SMD 24W	1680Lm	120°	WH	Φ213x68mm	Φ190mm

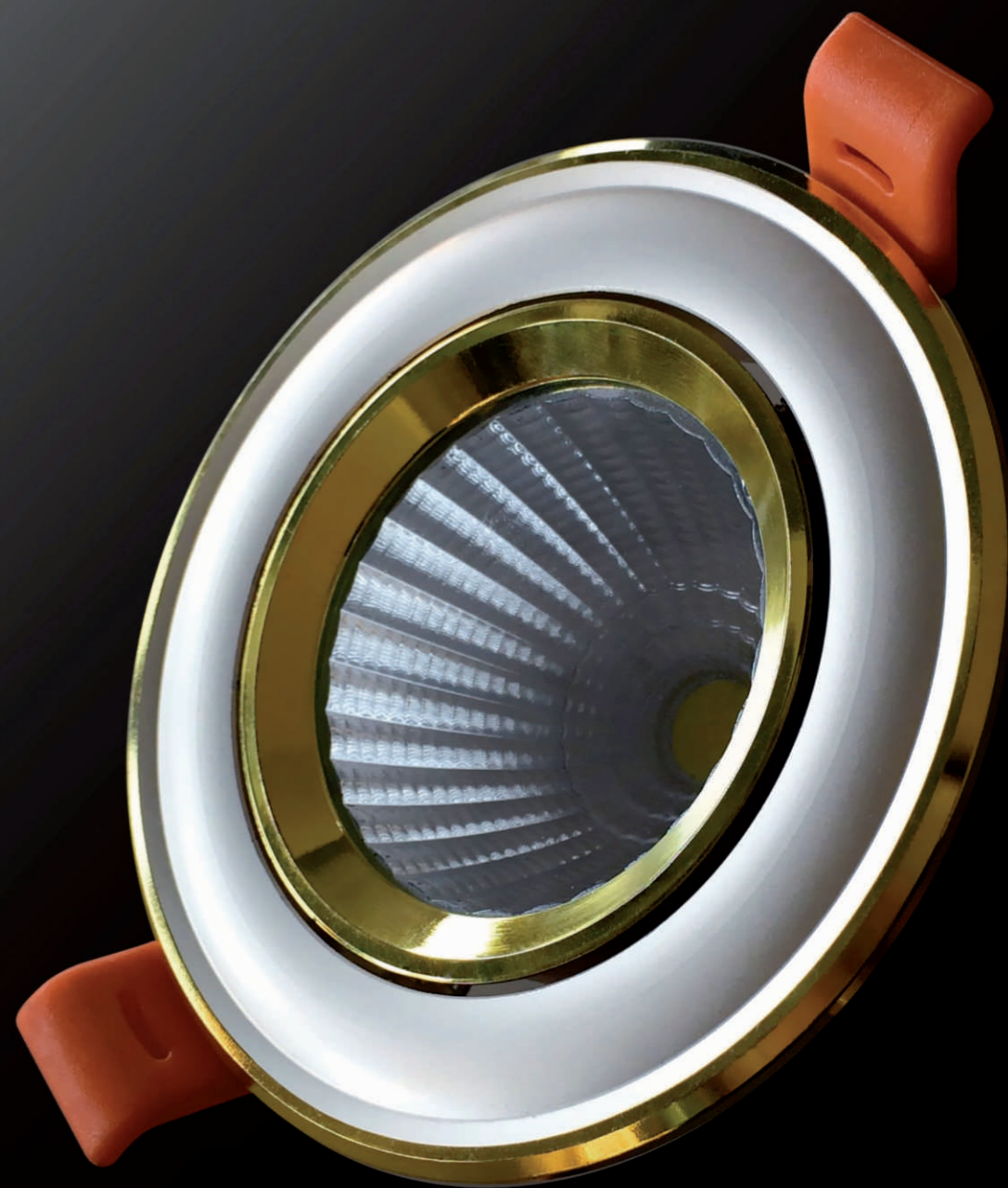

LED Spot Light

this kind of products are widely applied to hotel, store, home, museum and some other indoor places as the important spot lighting scenarios.



Model No: V-CLQ6607R	Surface Treatment: SL+HG/WH+SL
Power: COB 7W	Life Span: 30000H
Input Voltage: AC100-240V 50/60Hz	Material: Alum+PC+Glass
Luminous Flux: 560Lm	Working Temperature: -10~45° C
CRt: ≥80	IP: 20
Beam Angle: 38°	Body Size: Φ90*52mm
Color Temperature: 6500/4000/3000K	Hole Size: Φ80mm



V-CLQ6607R

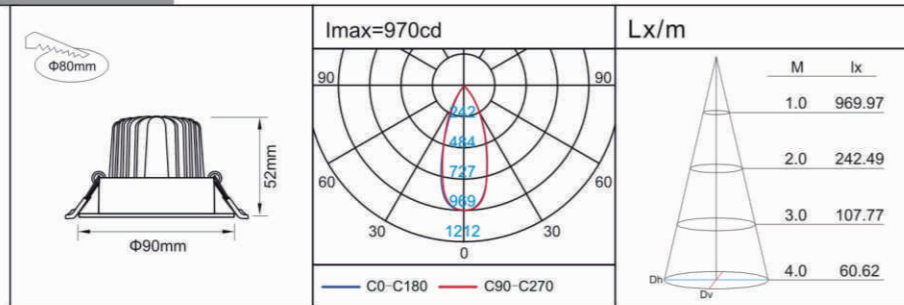

Products list

Model No.	Power	Luminous Flux	Beam angle	Surface	Body Size	Hole Size
V-CLQ6607R	COB 7W	560Lm	38°	SL+HG/WH+SL	Φ90x52mm	Φ80mm
V-CLQ6612R	COB 12W	960Lm	38°	SL+HG/WH+SL	Φ110x68mm	Φ95mm

Model No: V-0504	Surface Treatment: WH/CH/HG
Power: COB 8W	Life Span: 30000H
Input Voltage: AC220-240V 50/60Hz	Material: Alum+PC+Glass
Luminous Flux: 620Lm	Working Temperature: -10~45° C
CRt: ≥70	IP: 20
Beam Angle: 60°	Body Size: Φ95*55mm
Color Temperature: 6500/4000/3000K	Hole Size: Φ85mm



V-0504

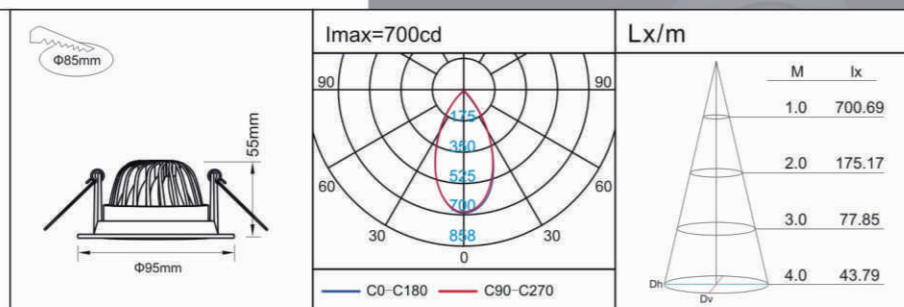

Model No: V-GLQ0515S-1B	Surface Treatment: WH
Power: COB 15W	Life Span: 30000H
Input Voltage: AC220-240V 50/60Hz	Material: Alum+PC
Luminous Flux: 1400Lm	Working Temperature: -10~45° C
CRt: ≥85	IP: 20
Beam Angle: 24°	Body Size: 116*116*98mm
Color Temperature: 6500/4000/3000K	Hole Size: 105*105mm



V-GLQ0515S-1B

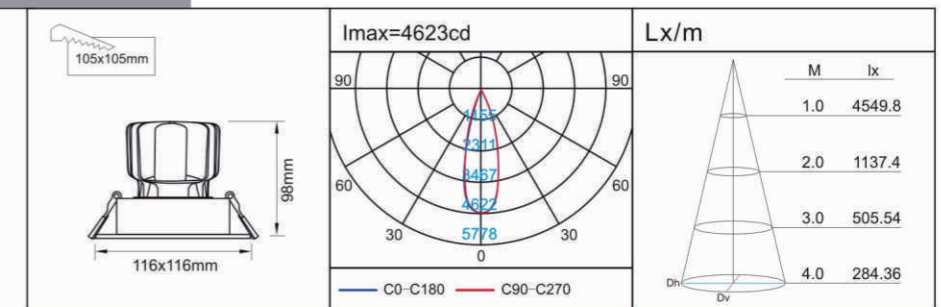

Products list

Model No.	Power	Luminous Flux	Beam angle	Surface	Body Size	Hole Size
V-GLQ0515S-1B	COB 15W	1400Lm	24°	WH	116x116x98mm	105x105mm
V-GLQ0515L-2B	COB 2x15W	2800Lm	2x24°	WH	214x116x98mm	200x105mm
V-GLQ0515L-3B	COB 3x15W	4300Lm	3x24°	WH	307x116x98mm	290x105mm
V-GLQ0530S-1B	COB 30W	3600Lm	24°	WH	176x176x138mm	160x160mm
V-GLQ0530L-2B	COB 2x30W	6000Lm	2x24°	WH	325x176x138mm	310x160mm
V-GLQ0530L-3B	COB 3x30W	9000Lm	3x24°	WH	475x176x138mm	460x160mm



Model No: V-PQ0745L	Surface Treatment: WH+BK
Power: COB 45W	Life Span: 30000H
Input Voltage: AC220-240V 50/60Hz	Material: Alum+Glass
Luminous Flux: 3800Lm	Working Temperature: -10~45° C
CRt: ≥80	IP: 20
Beam Angle: 90°	Body Size: 246*153*145mm
Color Temperature: 6500/4000/3000K	Hole Size: 235*130mm



Model No: MD-PQ1040L	Surface Treatment: WH
Power: COB 40W	Life Span: 25000H
Input Voltage: AC220-240V 50/60Hz	Material: Alum+PC+Glass
Luminous Flux: 3100Lm	Working Temperature: -10~45° C
CRt: ≥80	IP: 20
Beam Angle: 100°	Body Size: 230*145*110mm
Color Temperature: 6500/4000/3000K	Hole Size: 220*130mm

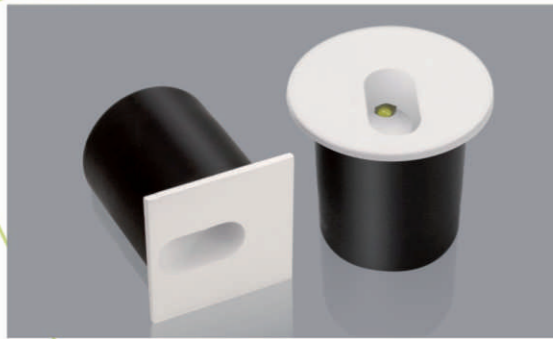

Model No: V-CLM0603R/ V-CLM0703S	Surface Treatment: WH
Power: High power 3W	Life Span: 30000H
Input Voltage: AC220-240V 50/60Hz	Material: Alum+PC
Luminous Flux: 60Lm	Working Temperature: -10~45° C
CRI: ≥75	IP: 20
Beam Angle: /	Body Size: 45*50mm
Color Temperature: 6500/4000/3000K	Hole Size: /



Model No: V-CLM0803R/S	Surface Treatment: WH
Power: SMD 3W	Life Span: 30000H
Input Voltage: AC220-240V 50/60Hz	Material: Alum+PC
Luminous Flux: 320Lm	Working Temperature: -10~45° C
CRI: ≥75	IP: 20
Beam Angle: /	Body Size: 60*55mm
Color Temperature: 6500/4000/3000K	Hole Size: /

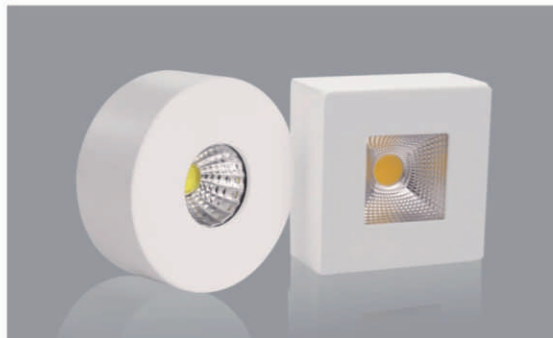

Model No: V-CLM0903R/S	Surface Treatment: WH
Power: COB 3W	Life Span: 30000H
Input Voltage: AC220-240V 50/60Hz	Material: Alum+Glass
Luminous Flux: 250Lm	Working Temperature: -10~45° C
CRI: ≥75	IP: 20
Beam Angle: /	Body Size: 60*23mm
Color Temperature: 6500/4000/3000K	Hole Size: /



Model No: V-1004	Surface Treatment: SL
Power: High power 1W	Life Span: 30000H
Input Voltage: AC100-240V 50/60Hz	Material: Alum+PC
Luminous Flux: 70Lm	Working Temperature: -10~45° C
CRI: ≥70	IP: 20
Beam Angle: 45°	Body Size: Φ30*33mm
Color Temperature: 6500/4000/3000K	Hole Size: Φ20mm



Model No: V-3007A	Surface Treatment: WH
Power: COB 7W	Life Span: 30000H
Input Voltage: AC220-240V 50/60Hz	Material: Alum+Glass
Luminous Flux: 660Lm	Working Temperature: -10~45° C
CRI: ≥75	IP: 20
Beam Angle: 45°	Body Size: Φ85*62mm
Color Temperature: 6500/4000/3000K	Hole Size: Φ75mm



V-3007A

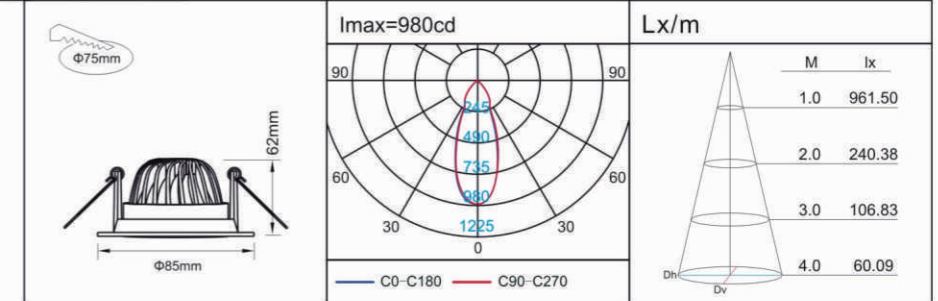

V-3112A

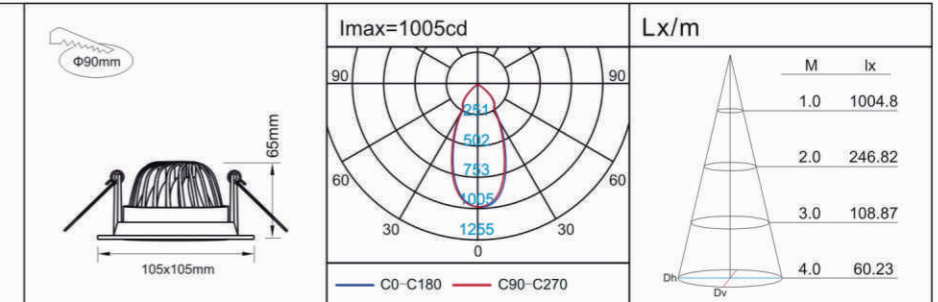

V-3212A

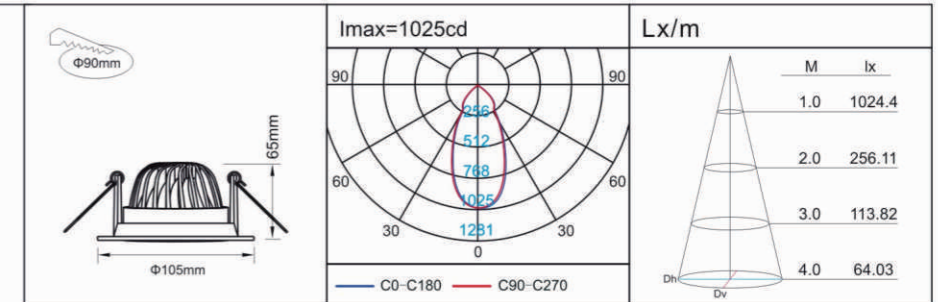

Products list

Model No.	Power	Luminous Flux	Beam angle	Surface	Body Size	Hole Size
V-3007A	COB 7W	660Lm	45°	WH	Φ85x62mm	Φ75mm
V-3012A	COB 12W	850Lm	45°	WH	Φ105x65mm	Φ90mm
V-3107A	COB 7W	660Lm	45°	WH	85x85x62mm	Φ75mm
V-3112A	COB 12W	850Lm	45°	WH	105x105x65mm	Φ90mm
V-3207A	COB 7W	660Lm	45°	WH	Φ85x62mm	Φ75mm
V-3212A	COB 12W	850Lm	45°	WH	Φ105x65mm	Φ90mm
V-3212A-D	COB 12W	Dimmable 0~850Lm	45°	WH	Φ105x65mm	Φ90mm



Model No: MD-CLQ2305R	Surface Treatment: WH
Power: COB 5W	Life Span: 25000H
Input Voltage: AC220-240V 50/60Hz	Material: Alum+PC
Luminous Flux: 420Lm	Working Temperature: -10~45° C
CRI: ≥80	IP: 20
Beam Angle: 40°	Body Size: Φ85*62mm
Color Temperature: 6500/4000/3000K	Hole Size: Φ75mm



MD-CLQ2305R

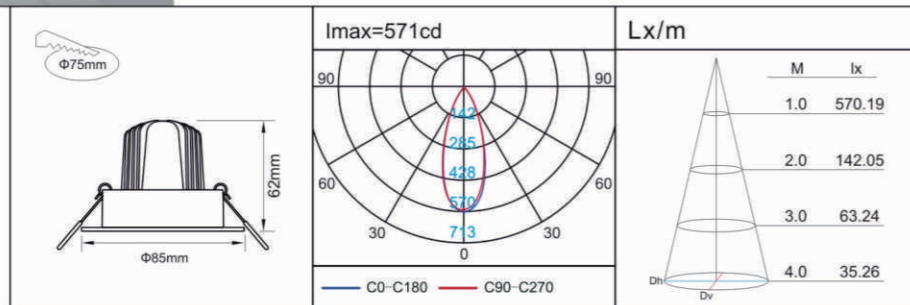

Products list

Model No.	Power	Luminous Flux	Beam angle	Surface	Body Size	Hole Size
MD-CLQ2305R	COB 5W	420Lm	40°	WH	Φ85x62mm	Φ75mm
MD-CLQ2308R	COB 8W	720Lm	40°	WH	Φ100x62mm	Φ80mm

Model No: MD-K0005W	Surface Treatment: WH+WH
Power: COB 7W	Life Span: 25000H
Input Voltage: AC220-240V 50/60Hz	Material: Alum+Glass
Luminous Flux: 600Lm	Working Temperature: -10~45° C
CRI: ≥70	IP: 20
Beam Angle: 100°	Body Size: Φ82*55mm
Color Temperature: 6500/4000/3000K	Hole Size: Φ70mm

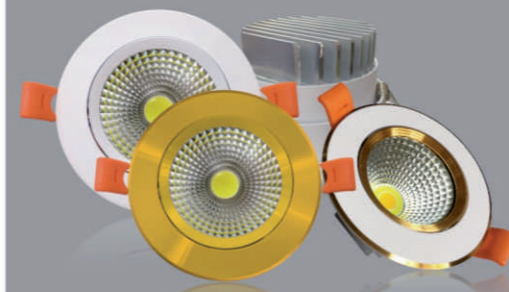

MD-K0005W

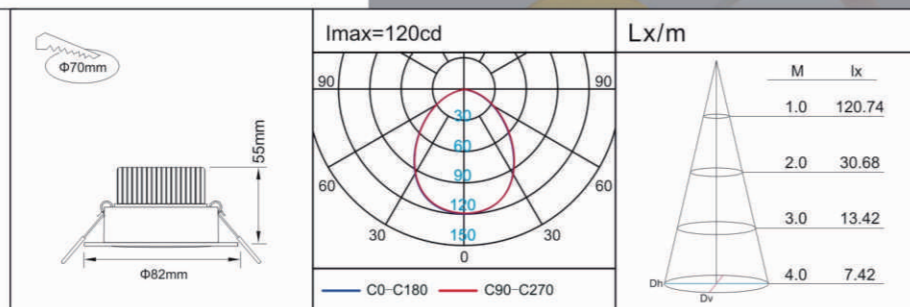

Products list

Model No.	Power	Luminous Flux	Beam angle	Surface	Body Size	Hole Size
MD-K0005W/G/S/HG	COB 7W	600Lm	100°	WH+WH/WH+HG/ WH+SL/HG	Φ82x55mm	Φ70mm
MD-K0008W/G/S/HG	COB 10W	1020Lm	100°		Φ108x57mm	Φ90mm
MD-K0005W/G/S/HG-RF	COB 7W	600Lm	100°	CCT(Switch control) 3 Color	Φ82x55mm	Φ70mm
MD-K0008W/G/S/HG-RF	COB 10W	1020Lm	100°		Φ108x57mm	Φ90mm



Model No: MD-CLQ0207R	Surface Treatment: WH
Power: COB 7W	Life Span: 25000H
Input Voltage: AC220-240V 50/60Hz	Material: Alum+Glass
Luminous Flux: 680Lm	Working Temperature: -10~45° C
CRI: ≥85	IP: 20
Beam Angle: 38°	Body Size: Φ85*55mm
Color Temperature: 6500/4000/3000K	Hole Size: Φ75mm



MD-CLQ0207R

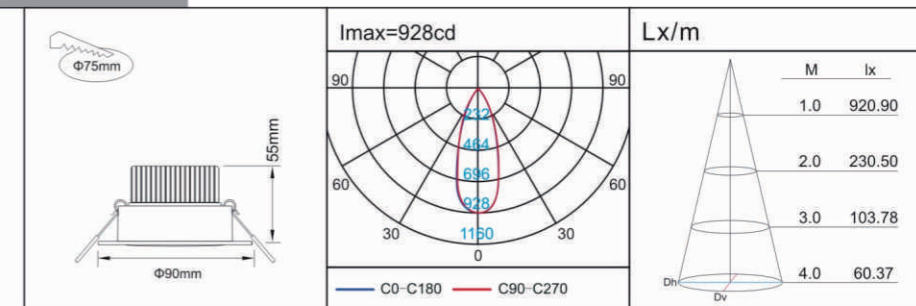

Products list

Model No.	Power	Luminous Flux	Beam angle	Surface	Body Size	Hole Size
MD-CLQ0207R	COB 7W	680Lm	38°	WH	Φ90x55mm	Φ75mm
MD-CLQ0212R	COB 12W	1100Lm	60°	WH	Φ109x63mm	Φ95mm
MD-CLQ0220R	COB 20W	1900Lm	38°	WH	Φ140x71mm	Φ125mm

Model No: MD-P3412R	Surface Treatment: WH
Power: COB 12W	Life Span: 25000H
Input Voltage: AC220-240V 50/60Hz	Material: Alum+PC
Luminous Flux: 1100Lm	Working Temperature: -10~45° C
CRI: ≥85	IP: 20
Beam Angle: 18°	Body Size: Φ73*145mm
Color Temperature: 6500/4000/3000K	Hole Size: /



MD-P3412R

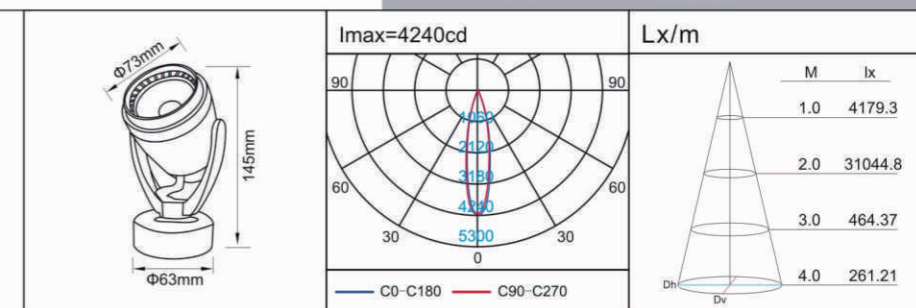

Products list

Model No.	Power	Luminous Flux	Beam angle	Surface	Body Size
MD-P3412R	COB 12W	1100Lm	18°	WH	Φ73x145mm
MD-P3430R	COB 30W	2400Lm	18°	WH	Φ105x205mm

V.MAX[®] LED Spot Light



Model No: V-PAR30-30W	Surface Treatment: WH
Power: COB 30W	Lamp Holder: E27/B22
Input Voltage: AC220-240V 50/60Hz	Life Span: 30000H
Luminous Flux: 2800Lm	Material: Alum+PC
CRt: ≥70	Working Temperature: -10~45° C
Beam Angle: 18°	IP: 20
Color Temperature: 6500/4000/3000K	Body Size: Φ90*118mm



Model No: V-1002
Power: Suitable of Lamp cup (Mr16)
Input Voltage: AC220-240V 50/60Hz
Surface Treatment: WH/SN/CH/HG/SBK
Body Size: Φ83*29mm
Hole Size: Φ75mm

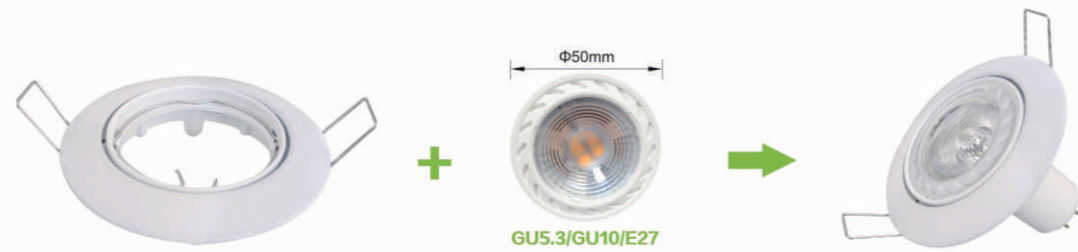

LED Source Series

this kind of products are widely applied to hotel, store, home, museum and some indoor important scene light.



Model No: V-LC1307	Surface Treatment: WH
Power: SMD 7W	Lamp Holder: G5.3/Gu10
Input Voltage: AC220-240V 50/60Hz	Life Span: 30000H
Luminous Flux: 600Lm	Material: Alum+PC
CRt: ≥80	Working Temperature: -10~45° C
Beam Angle: 38°	IP: 20
Color Temperature: 6500/4000/3000K	Body Size: Φ50*49mm



V-LC1307

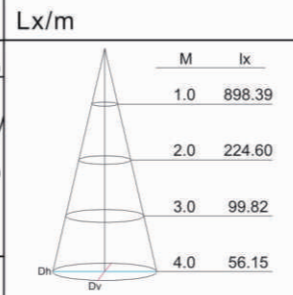
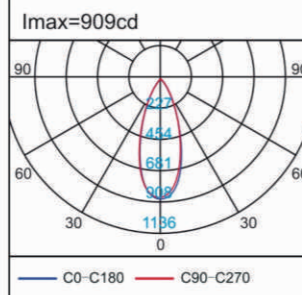
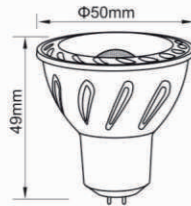

Products list

Model No.	Power	Luminous Flux	Beam angle	Surface	Body Size
V-LC1303	SMD 3W	240Lm	38°	WH	Φ50x49mm
V-LC1307	SMD 7W	600Lm	38°	WH	Φ50x49mm
V-LC1307D	SMD 6W	Dimmable 0~500Lm	38°	WH	Φ50x49mm



Model No: V-LC1609	Surface Treatment: WH
Power: COB 9W	Lamp Holder: G5.3/Gu10
Input Voltage: AC220-240V 50/60Hz	Life Span: 30000H
Luminous Flux: 720Lm	Material: Alum+PC
CRt: ≥80	Working Temperature: -10~45° C
Beam Angle: 35°	IP: 20
Color Temperature: 6500/4000/3000K	Body Size: Φ49*52mm



Model No: MD-LC2706	Surface Treatment: WH
Power: SMD 6W	Lamp Holder: G5.3/Gu10
Input Voltage: AC220-240V 50/60Hz	Life Span: 25000H
Luminous Flux: 480Lm	Material: Alum+PC
CRt: ≥80	Working Temperature: -10~45° C
Beam Angle: 35°	IP: 20
Color Temperature: 6500/4000/3000K	Body Size: Φ50*53mm



Model No: MD-B0808	Surface Treatment: Clear/Amber
Power: Filament 8*1W	Lamp Holder: E14/E27/B22
Input Voltage: AC220-240V 50/60Hz	Life Span: 25000H
Luminous Flux: 1050Lm	Material: Alum+Glass
CRt: ≥80	Working Temperature: -10~45° C
Beam Angle: 360°	IP: 50
Color Temperature: 6500/4000/3000/2700K	Body Size: Φ60*104mm



MD-B0808

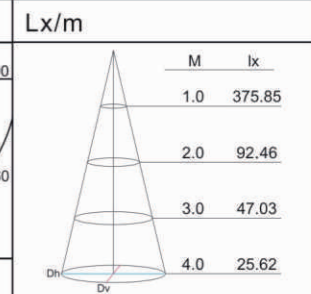
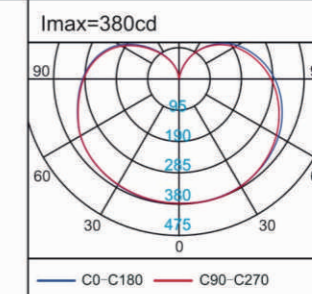
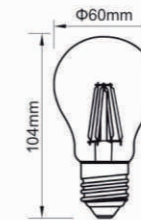

Products list

Model No.	Power	Luminous Flux	Beam angle	Surface	Body Size
MD-B0808	Filament 8x1W	1050Lm	360°	Clear/Amber	Φ60x104mm
MD-B0404-G45	Filament 3.5W	480Lm	360°	Clear/Amber	Φ45x80mm

Model No: MD-CB0404	Surface Treatment: Clear
Power: Filament 4*1W	Lamp Holder: E14/E27
Input Voltage: AC220-240V 50/60Hz	Life Span: 25000H
Luminous Flux: 480Lm	Material: Alum+Glass
CRt: ≥80	Working Temperature: -10~45° C
Beam Angle: 360°	IP: 50
Color Temperature: 6500/4000/3000/2700K	Body Size: Φ35*117mm



MD-CB0404

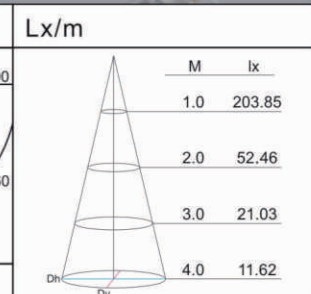
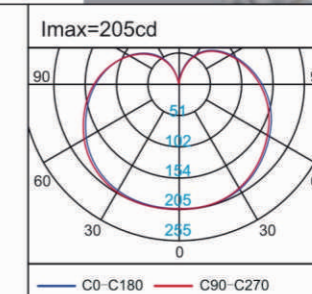
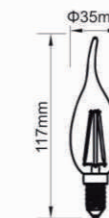

Products list

Model No.	Power	Luminous Flux	Beam angle	Surface	Body Size
MD-CB0404	Filament 4x1W	480Lm	360°	Clear/Amber	Φ35x117mm
MD-CB0404D	Filament 4x1W	Dimmable 50~480Lm	360°	Clear/Amber	Φ35x117mm
MD-TB0404	Filament 4x1W	480Lm	360°	Clear/Amber	Φ35x100mm
MD-TB0404D	Filament 4x1W	Dimmable 50~480Lm	360°	Clear/Amber	Φ35x100mm

V.MAX[®] LED Fluorescent Lamp



Model No: V-T2FS-11 SUPER	Surface Treatment: WH
Power: 11W	Lamp Holder: E14/E27/B22
Input Voltage: AC220-240V 50/60Hz	Life Span: 8000H
Luminous Flux: 510Lm	Material: Glass+PC
CRt: ≥80	Working Temperature: -10-45° C
Beam Angle: 360°	IP: 20
Color Temperature: 6500/4000/3000K	Body Size: Φ33*100mm



V-T2FS-11 SUPER

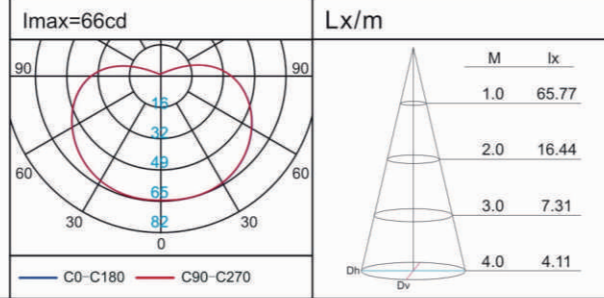
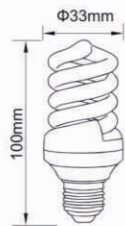

Products list

Model No.	Power	Luminous Flux	Beam angle	Surface	Body Size
V-T2FS-11 SUPER	11W	510Lm	360°	WH	Φ33x100mm
V-T2HS-18 SUPER	18W	900Lm	360°	WH	Φ40x102mm
V-T2HS-30 SUPER	30W	1480Lm	360°	WH	Φ52x120mm
V-SFS-15	15W	700Lm	360°	WH	Φ38x108mm
V-MFS-20	20W	935Lm	360°	WH	Φ48x130mm

Model No: V-M3U-18 SUPER+EMC	Surface Treatment: WH
Power: 18W	Lamp Holder: E14/E27/B22
Input Voltage: AC220-240V 50/60Hz	Life Span: 8000H
Luminous Flux: 840Lm	Material: Glass+PC
CRt: ≥80	Working Temperature: -10-45° C
Beam Angle: 360°	IP: 20
Color Temperature: 6500/4000/3000K	Body Size: Φ43*128mm



V-M3U-18 SUPER+EMC

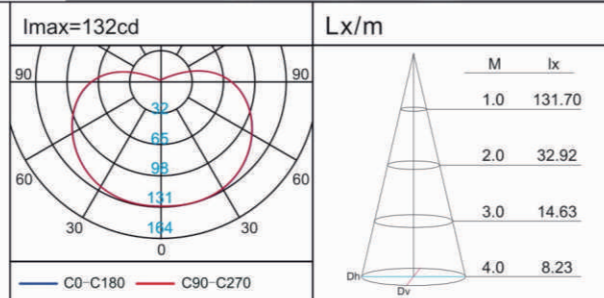
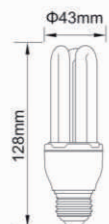

Products list

Model No.	Power	Luminous Flux	Beam angle	Surface	Body Size
V-M3U-18 SUPER+EMC	18W	840Lm	360°	WH	Φ43x128mm
V-B3U-26	26W	1260Lm	360°	WH	Φ53x168mm

Corn Lamp & Bulb Lamp V.MAX[®]



Model No: MD-S3U09T	Surface Treatment: Clear
Power: SMD 9W	Lamp Holder: E27/B22
Input Voltage: AC220-240V 50/60Hz	Life Span: 25000H
Luminous Flux: 630Lm	Material: Alum+Glass+PC
CRt: ≥70	Working Temperature: -10-45° C
Beam Angle: 270°	IP: 20
Color Temperature: 6500/4000/3000K	Body Size: Φ42*141mm



MD-S3U09T

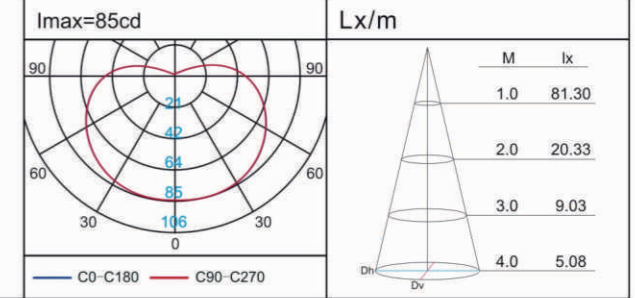
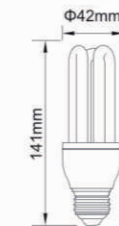

Products list

Model No.	Power	Luminous Flux	Beam angle	Surface	Body Size
MD-S3U09T	SMD 9W	630Lm	270°	WH	Φ42x141mm
MD-S3U12T	SMD 12W	1200Lm	270°	WH	Φ42x142mm
MD-M3U16T	SMD 16W	1120Lm	270°	WH	Φ52x172mm
MD-M4U18T	SMD 18W	1800Lm	270°	WH	Φ58x179mm
MD-B4U24T	SMD 24W	2400Lm	270°	WH	Φ72x220mm
MD-B4U36T	SMD 36W	3600Lm	270°	WH	Φ71x250mm

Model No: MD-B2220	Surface Treatment: WH
Power: SMD 20W	Lamp Holder: E27/B22
Input Voltage: AC220-240V 50/60Hz	Life Span: 25000H
Luminous Flux: 1750Lm	Material: Alum+PC
CRt: ≥85	Working Temperature: -10-45° C
Beam Angle: 180°	IP: 50
Color Temperature: 6500/4000/3000K	Body Size: Φ70*155mm



MD-B2220

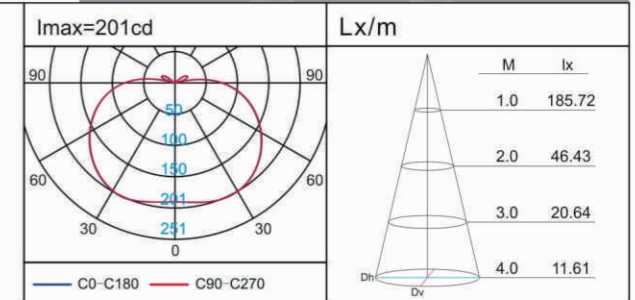
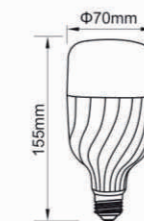

Products list

Model No.	Power	Luminous Flux	Beam angle	Surface	Body Size
MD-B2220	SMD 20W	1750Lm	180°	WH	Φ70x155mm
MD-B2224	SMD 24W	2150Lm	180°	WH	Φ80x171mm



Model No: V-B3020	Surface Treatment: WH
Power: SMD 20W	Lamp Holder: E27/B22
Input Voltage: AC220-240V 50/60Hz	Life Span: 30000H
Luminous Flux: 2000Lm	Material: Alum+PC
CRt: ≥80	Working Temperature: -10~45° C
Beam Angle: 180°	IP: 50
Color Temperature: 6500/4000/3000K	Body Size: Φ80*150mm



V-B3020

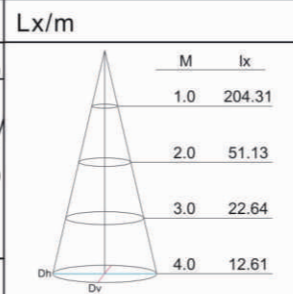
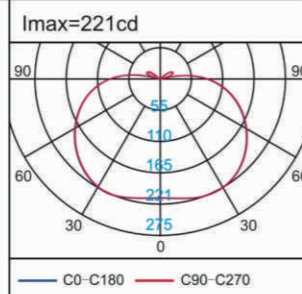
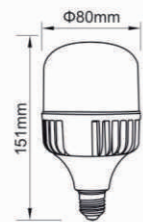

Products list

Model No.	Power	Luminous Flux	Beam angle	Surface	Body Size
V-B3020	SMD 20W	2000Lm	180°	WH	Φ80x150mm
V-B3030	SMD 30W	3200Lm	180°	WH	Φ100x180mm
V-B3045	SMD 45W	4200Lm	180°	WH	Φ120x210mm

Model No: V-B3109	Surface Treatment: WH
Power: SMD 9W	Lamp Holder: E27/B22
Input Voltage: AC220-240V 50/60Hz	Life Span: 30000H
Luminous Flux: 100Lm	Material: Alum+PC
CRt: ≥85	Working Temperature: -10~45° C
Beam Angle: 180°	IP: 20
Color Temperature: 6500/4000/3000K	Body Size: Φ60*116mm



V-B3109

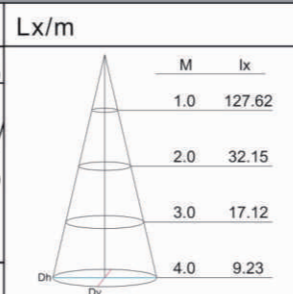
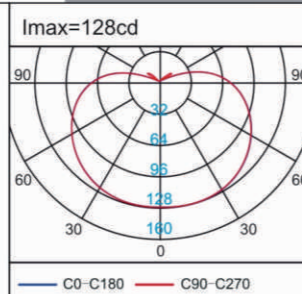
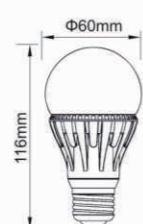

Products list

Model No.	Power	Luminous Flux	Beam angle	Surface	Body Size
V-B3109	SMD 9W	1000Lm	180°	WH	Φ60x116mm
V-B3112	SMD 12W	1500Lm	180°	WH	Φ70x134mm



Model No: V-CB1506	Surface Treatment: Clear+WH
Power: SMD 6W	Lamp Holder: E14
Input Voltage: AC220-240V 50/60Hz	Life Span: 30000H
Luminous Flux: 480Lm	Material: Alum+PC
CRt: ≥80	Working Temperature: -10~45° C
Beam Angle: 360°	IP: 50
Color Temperature: 6500/4000/3000K	Body Size: Φ37*127mm



V-CB1506

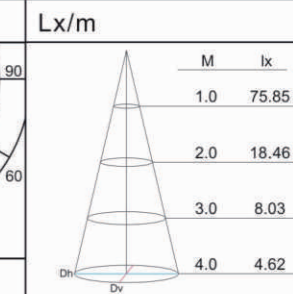
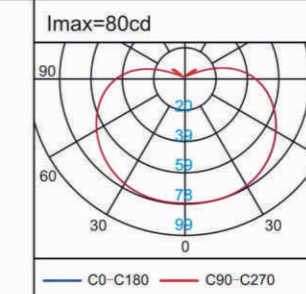
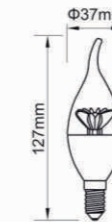

Products list

Model No.	Power	Luminous Flux	Beam angle	Surface	Body Size
V-CB1506	SMD 6W	480Lm	360°	Clear+WH	Φ37x127mm
V-TB1506	SMD 6W	480Lm	360°	Clear+WH	Φ37x114mm

Model No: MD-CB1505	Surface Treatment: Clear+WH
Power: SMD 5W	Lamp Holder: E14
Input Voltage: AC220-240V 50/60Hz	Life Span: 30000H
Luminous Flux: 420Lm	Material: Alum+PC
CRt: ≥80	Working Temperature: -10~45° C
Beam Angle: 360°	IP: 50
Color Temperature: 6500/4000/3000K	Body Size: Φ37*127mm



MD-CB1505

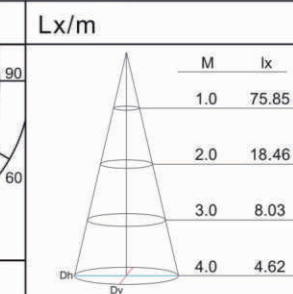
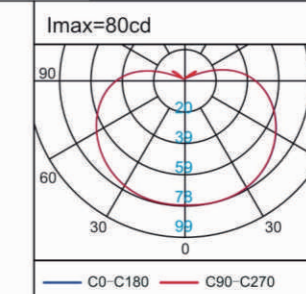

Products list

Model No.	Power	Luminous Flux	Beam angle	Surface	Body Size
MD-CB1505	SMD 5W	420Lm	360°	Diffuse+WH	Φ37x127mm
MD-TB1505	SMD 5W	420Lm	360°	Diffuse+WH	Φ37x114mm



Model No: MD-B1110-B	Surface Treatment: WH
Power: SMD 9W	Lamp Holder: E27/B22
Input Voltage: AC220-240V 50/60Hz	Life Span: 25000H
Luminous Flux: 950Lm	Material: Alum+PC
CRi: ≥80	Working Temperature: -10-45° C
Beam Angle: 200°	IP: 50
Color Temperature: 6500/4000/3000K	Body Size: Φ60*108/117mm



MD-B1110-B

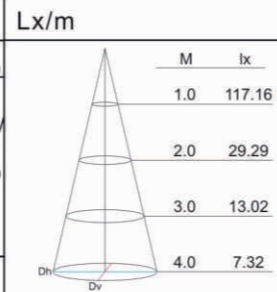
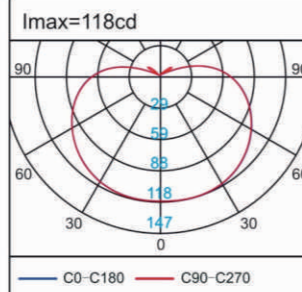
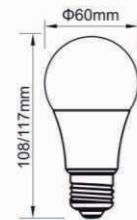

Products list

Model No.	Power	Luminous Flux	Beam angle	Surface	Body Size
MD-B1105	SMD 4.5W	420Lm	200°	WH	Φ50x96mm
MD-B1110-B	SMD 9W	950Lm	200°	WH	Φ60x108/117mm
MD-B1114-A	SMD 12W	1400Lm	200°	WH	Φ70x134/127mm
MD-B1116	SMD 15W	1600Lm	200°	WH	Φ80x146mm

Item NO: MD-BR63-9	Surface Treatment: WH
Power: SMD 9W	Lamp Holder: E27/B22
Input Voltage: AC220-240V 50/60Hz	Life Span: 25000H
Luminous Flux: 900Lm	Material: Alum+PC
CRi: ≥75	Working Temperature: -10-45° C
Beam Angle: 120°	IP: 50
Color Temperature: 6500/4000/3000K	Product Size: Φ63*104mm



MD-BR63-9

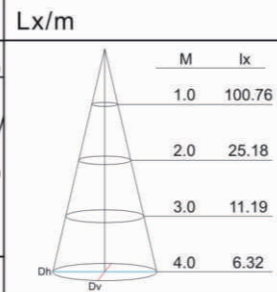
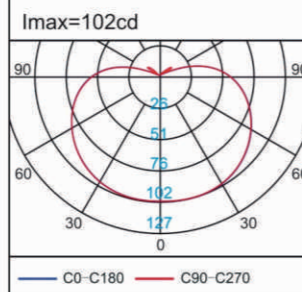
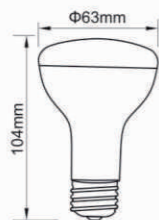

Products list

Item NO.	Power	Luminous Flux	Beam angle	Surface	Specification
MD-BR63-9	SMD 9W	900Lm	120°	WH	Φ63x104mm
MD-BR80-12	SMD 12W	1200Lm	120°	WH	Φ80x113mm



220V-E14-2.5W-2835-51D

Model No: MODI E14	Surface Treatment: Clear
Power: SMD 2.5W	Lamp Holder: E14
Input Voltage: AC220-240V 50/60Hz	Life Span: 25000H
Luminous Flux: 100lm/W	Material: PC
CRi: ≥75	Working Temperature: -10-45° C
Beam Angle: 300°	IP: 20
Color Temperature: 6500/4000/3000K	Body Size: Φ18*69mm



220V-G9-3.5W-2835-22D

Model No: MODI G9	Surface Treatment: Diffuse
Power: SMD 3.5W	Lamp Holder: G9
Input Voltage: AC220-240V 50/60Hz	Life Span: 25000H
Luminous Flux: 80lm/W	Material: PC
CRi: ≥80	Working Temperature: -10-45° C
Beam Angle: 300°	IP: 20
Color Temperature: 6500/4000/3000K	Body Size: Φ14*51mm



220V-G4-2W-2835-33D

Model No: MODI G4	Surface Treatment: Clear
Power: SMD 2W	Lamp Holder: G4
Input Voltage: AC220-240V 50/60Hz	Life Span: 25000H
Luminous Flux: 90lm/W	Material: PC
CRi: ≥80	Working Temperature: -10-45° C
Beam Angle: 300°	IP: 20
Color Temperature: 6500/4000/3000K	Body Size: Φ14*40mm

AD-12V-G4-2.5W-2835-33D

Model No: MODI G4	Surface Treatment: Clear
Power: SMD 2.5W	Lamp Holder: G4
Input Voltage: AC/DC12V	Life Span: 25000H
Luminous Flux: 90lm/W	Material: PC
CRi: ≥80	Working Temperature: -10-45° C
Beam Angle: 300°	IP: 20
Color Temperature: 6500/4000/3000K	Body Size: Φ14*40mm



3 mode
 ■ Steady
 ■ Flaming
 ■ Gradual Changing

Model No: MD-B2505	Surface Treatment: WH
Power: SMD 5W	Lamp Holder: E27/B22
Input Voltage: AC220-240V 50/60Hz	Life Span: 25000H
Luminous Flux: 360Lm	Material: Alum+Glass+PC
CRi: ≥80	Working Temperature: -10-45° C
Beam Angle: 270°	IP: 20
Color Temperature: WW	Body Size: Φ49*128mm

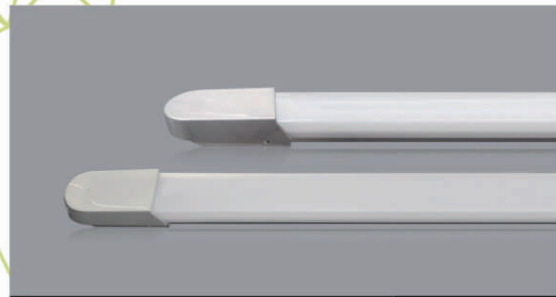

Model No: V-PD60A-18	Surface Treatment: WH
Power: SMD 18W	Lamp Holder: /
Input Voltage: AC220-240V 50/60Hz	Life Span: 30000H
Luminous Flux: 1400Lm	Material: Alum+PC
CRt: ≥80	Working Temperature: -10~45° C
Beam Angle: 120°	IP: 20
Color Temperature: 6500/4000/3000K	Body Size: 600*48*28mm

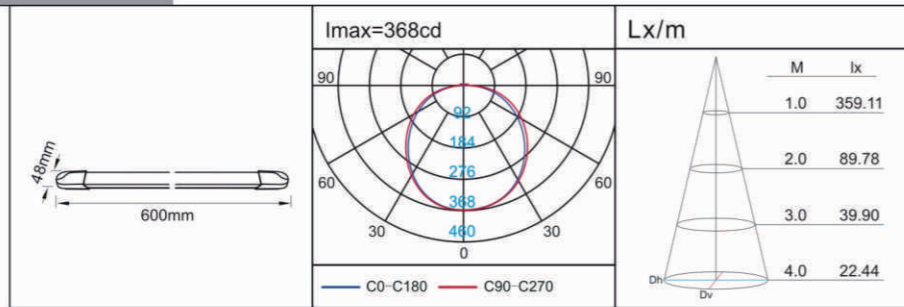

Products list

Model No.	Power	Luminous Flux	Beam angle	Surface	Body Size
V-PD60A-18	SMD 18W	1400Lm	120°	WH	600x48x28mm
V-PD90A-28	SMD 28W	2400Lm	120°	WH	900x48x28mm
V-PD120A-38	SMD 38W	3080Lm	120°	WH	1200x48x28mm

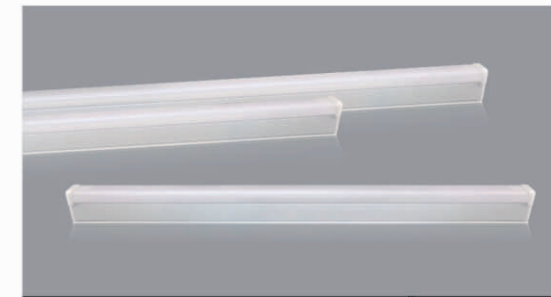

Model No: V-T530S-8Y	Surface Treatment: Diffuse/Clear
Power: SMD 8W	Lamp Holder: /
Input Voltage: AC220-240V 50/60Hz	Life Span: 30000H
Luminous Flux: 800Lm	Material: Alum+PC
CRt: ≥80	Working Temperature: -10~45° C
Beam Angle: 120°	IP: 20
Color Temperature: 6500/4000/3000K	Body Size: 300*22*34mm

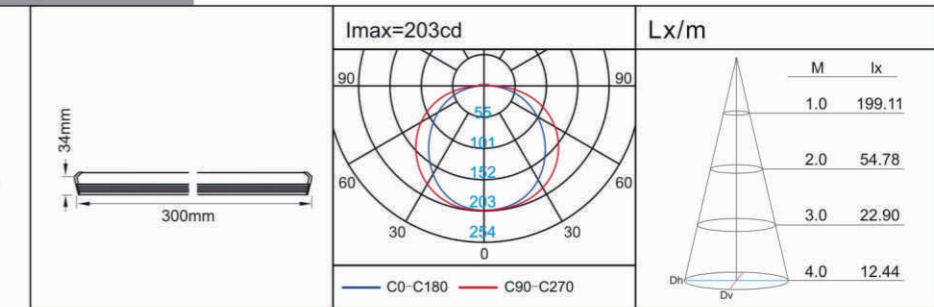

Products list

Model No.	Power	Luminous Flux	Beam angle	Surface	Body Size
V-T530S-8Y	SMD 8W	800Lm	120°	Diffuse /Clear	300x22x34mm
V-T560S-16Y	SMD 16W	1450Lm	120°	Diffuse /Clear	600x22x34mm
V-T590S-24Y	SMD 24W	2100Lm	120°	Diffuse /Clear	900x22x34mm
V-T5120S-32Y	SMD 32W	2800Lm	120°	Diffuse /Clear	1200x22x34mm



Model No: MD-TP120-40	Surface Treatment: WH/Clear
Power: SMD 40W	Lamp Holder: /
Input Voltage: AC220-240V 50/60Hz	Life Span: 25000H
Luminous Flux: 2900Lm	Material: Alum+PC
CRt: ≥70	Working Temperature: -10~45° C
Beam Angle: 120°	IP: 20
Color Temperature: 6500/4000/3000K	Body Size: 1200*76*68mm



Model No: MD-PD120B-100	Surface Treatment: WH/Clear
Power: SMD 100W	Lamp Holder: /
Input Voltage: AC220-240V 50/60Hz	Life Span: 25000H
Luminous Flux: 7800Lm	Material: Alum+PC
CRt: ≥70	Working Temperature: -10~45° C
Beam Angle: 120°	IP: 20
Color Temperature: 6500/4000/3000K	Body Size: 1200*135*25mm

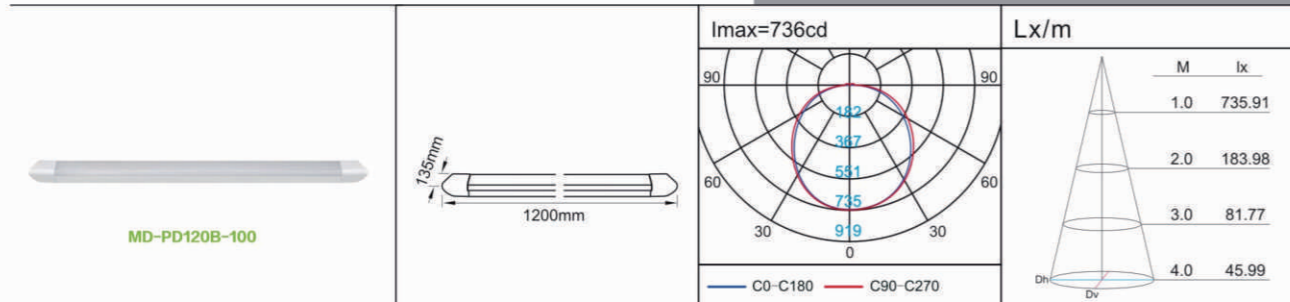

Products list

Model No.	Power	Luminous Flux	Beam angle	Surface	Body Size
MD-PD120B-64	SMD 64W	4480Lm	120°	WH/Clear	1200x70x25mm
MD-PD120B-100	SMD 100W	7800Lm	120°	WH/Clear	1200x135x25mm



Model No: MD-TP60A-2	Surface Treatment: WH
Power: Using for LED T8 Tube(0.6m)	Working Temperature: -10~50° C
Input Voltage: AC220-240V 50/60Hz	IP: 54
Material: ABS+PC	Body Size: 655*95*61mm

Model No: V-TP120A-2	Surface Treatment: WH
Power: Using for LED T8 Tube(1.2m)	Working Temperature: -10~50° C
Input Voltage: AC220-240V 50/60Hz	IP: 54
Material: ABS+PC	Body Size: 1280*95*61mm

V.MAX[®] T8 Tube^{LED}



Model No: V-T860R-15	Surface Treatment: WH/GL
Power: SMD 15W	Lamp Holder: G13
Input Voltage: AC220-240V 50/60Hz	Life Span: 25000H
Luminous Flux: 1500Lm	Material: Alum+Glass
CRt: ≥80	Working Temperature: -10~45° C
Beam Angle: 120°	IP: 20
Color Temperature: 6500/4000/3000K	Body Size: Φ28*600mm



V-T860R-15

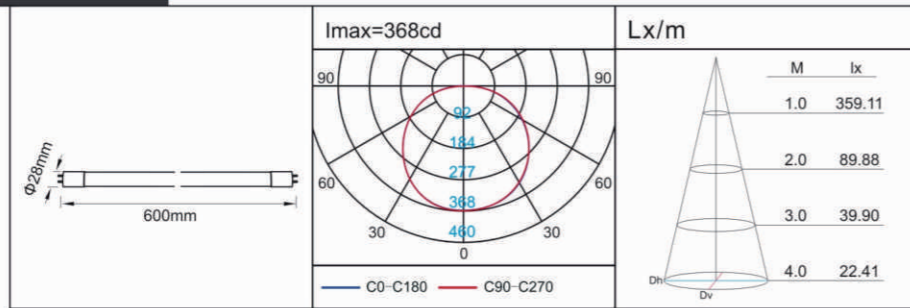

Products list

Model No.	Power	Luminous Flux	Beam angle	Surface	Body Size
V-T860R-15	SMD 15W	1500Lm	120°	WH/GL	Φ28x600mm
V-T8120R-24	SMD 24W	3200Lm	120°	WH/GL	Φ28x1200mm

Model No: MD-T860R-12	Surface Treatment: WH
Power: SMD 12W	Lamp Holder: G13
Input Voltage: AC220-240V 50/60Hz	Life Span: 25000H
Luminous Flux: 1200Lm	Material: Alum+Glass
CRt: ≥70	Working Temperature: -10~45° C
Beam Angle: 120°	IP: 20
Color Temperature: 6500/4000/3000K	Body Size: Φ28*600mm

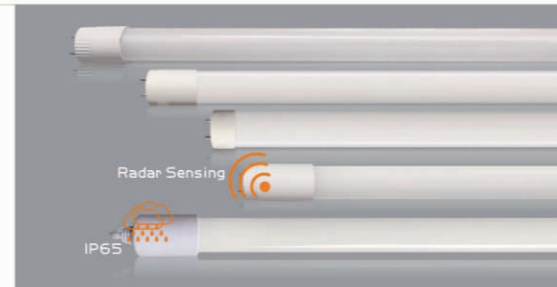

MD-T860R-12

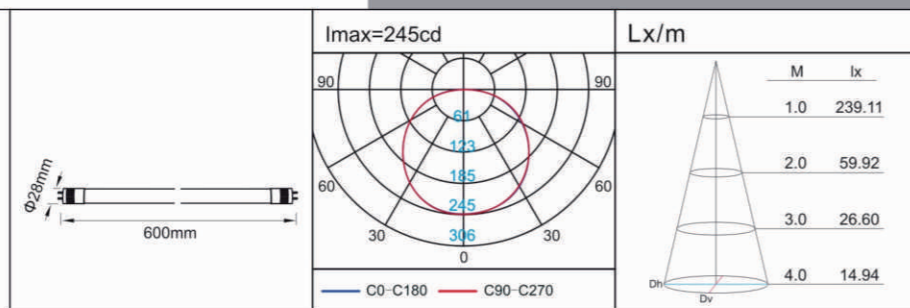

Products list

Model No.	Power	Luminous Flux	IP	Beam angle	Surface	Body Size
MD-T860R-12	SMD 12W	1200Lm	20	120°	WH	Φ28x600mm
MD-T8120R-18	SMD 18W	1600Lm	20	120°	WH	Φ28x1200mm
MD-T8120R-22	SMD 22W	2000Lm	20	120°	WH	Φ28x1200mm
MD-T8120R-24	SMD 24W	2400Lm	20	120°	WH	Φ28x1200mm
MD-T860R-09LG	SMD 9W(Radar Sensing)	1080Lm	20	120°	WH	Φ28x590mm
MD-T8120R-18LG	SMD 18W(Radar Sensing)	2100Lm	20	120°	WH	Φ28x1197mm
MD-T8120RA-18	SMD 18W(Waterproof)	2200Lm	65	120°	WH	Φ30x1195mm

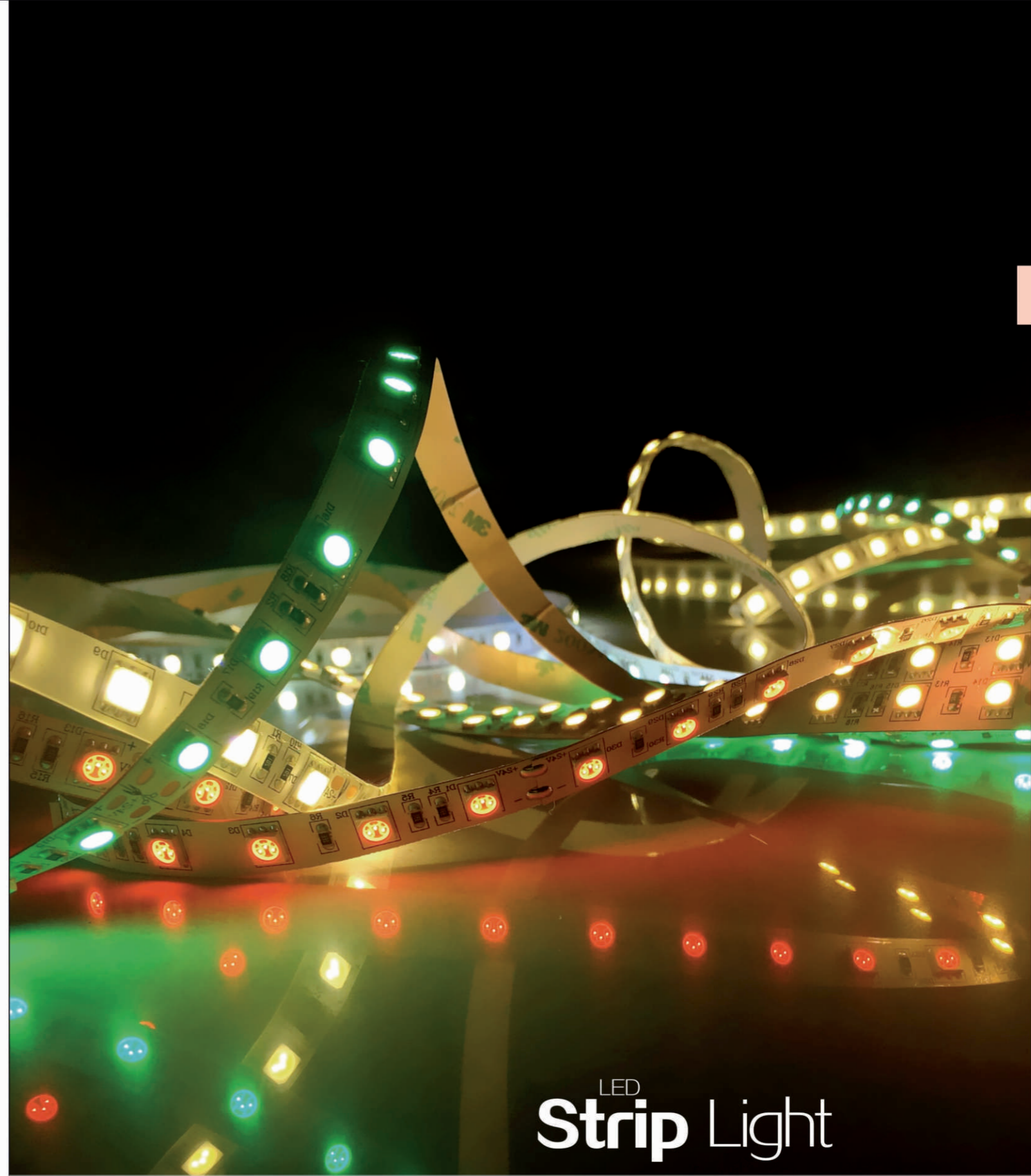

LED Strip Light

Widely applied to department stores, commercial hotel, shop Windows, clothing stores, the museum, and other decorative lighting places and other places.



V.MAX FS-5050-72-IP44

Power: SMD 7W/m	Plate Sizes: 10mm
Specification: 5050 72LEDs/m	Surface Treatment: WH
Input Voltage: AC220-240V 50/60Hz	Life Span: 30000H
Luminous Flux: ≥150Lm/m	Material: Cu+PC
Beam Angle: 120°	Working Temperature: -10~45° C
Color Temperature: WH/NW/WW/RED/ GREEN/BLUE/RGB.	IP: 44
	Manner Of Packing: 30m/Roll

V.MAX FS-2835-120-IP44

Power: SMD 8W/m	Plate Sizes: 5mm
Specification: 2835 120LEDs/m	Surface Treatment: WH
Input Voltage: AC220-240V 50/60Hz	Life Span: 30000H
Luminous Flux: ≥260Lm/m	Material: Cu+PC
Beam Angle: 120°	Working Temperature: -10~45° C
Color Temperature: WH/NW/WW/RED/ GREEN/BLUE/RGB.	IP: 44
	Manner Of Packing: 30m/Roll

V.MAX 360° 220V FS-2835-144-IP44

Power: SMD 7W/m	Plate Sizes: 5mm
Specification: 2835 144LEDs/m	Surface Treatment: WH
Input Voltage: AC220-240V 50/60Hz	Life Span: 30000H
Luminous Flux: ≥380Lm/m	Material: Cu+PC
Beam Angle: 360°	Working Temperature: -10~45° C
Color Temperature: WH/NW/WW/RED/ GREEN/BLUE/RGB.	IP: 44
	Manner Of Packing: 30m/Roll

FS-2835 Cable Clips

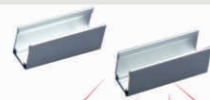

Parts:



Applications:

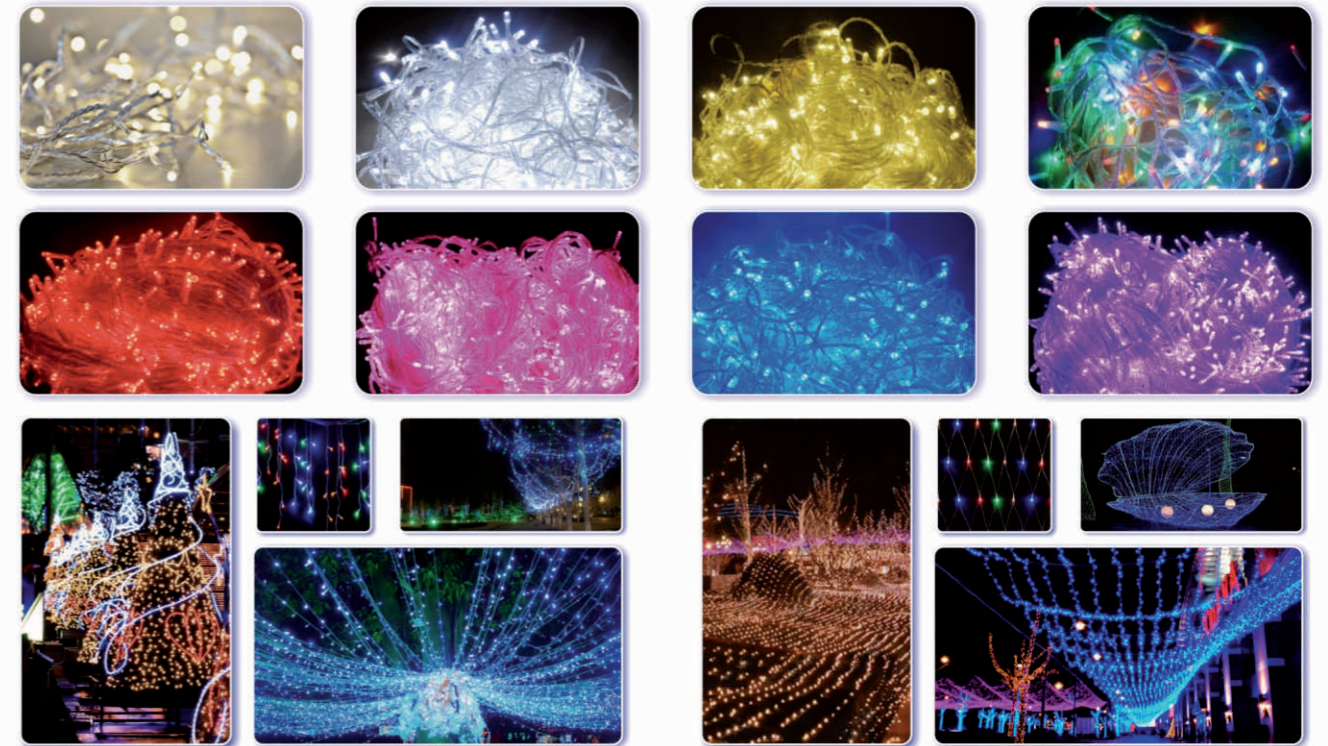

MODI 220V 50R-480-IP44

Power: 11W	Surface Treatment: WH
Specification: 480LEDs	Life Span: 25000H
Input Voltage: AC220-240V 50/60Hz	Material: Cu+PC
Beam Angle: 300°	Working Temperature: -10~45° C
Color Temperature: WH/NW/WW/RED/ GREEN/BLUE/RGB.	IP: 44
	Manner Of Packing: 50m/Pcs

MODI 220V 3*2.5-256-IP44

Power: 8W	Surface Treatment: WH
Specification: 256LEDs	Life Span: 25000H
Input Voltage: AC220-240V 50/60Hz	Material: Cu+PC
Beam Angle: 300°	Working Temperature: -10~45° C
Color Temperature: WH/NW/WW/RED/ GREEN/BLUE/RGB.	IP: 44
	Manner Of Packing: 3*2.5m/Pcs





VMAX 220V WB-5050-72-IP44

Power: SMD 8W/m	Plate Sizes: 12mm
Specification: 5050 72LEDs/m	Surface Treatment: WH
Input Voltage: AC220-240V 50/60Hz	Life Span: 30000H
Luminous Flux: ≥680Lm/m	Material: Cu+PC
Beam Angle: 120°	Working Temperature: -10~45° C
Color Temperature: WH/NW/WW/RED/ GREEN/BLUE/RGB.	IP: 44
	Manner Of Packing: 50m/Roll



VMAX 220V WB-2835-2*90-IP44

Power: SMD 8W/m	Plate Sizes: 14mm
Specification: 2835 180LEDs/m	Surface Treatment: WH
Input Voltage: AC220-240V 50/60Hz	Life Span: 30000H
Luminous Flux: ≥750Lm/m	Material: Cu+PC
Beam Angle: 120°	Working Temperature: -10~45° C
Color Temperature: WH/NW/WW/RED/ GREEN/BLUE/RGB.	IP: 44
	Manner Of Packing: 50m/Roll



MODI 220V WB-2835-3*92-IP44

Power: SMD 10W/m	Plate Sizes: 15mm
Specification: 2835 276LEDs/m	Surface Treatment: WH
Input Voltage: AC220-240V 50/60Hz	Life Span: 25000H
Luminous Flux: ≥720Lm/m	Material: Cu+PC
Beam Angle: 120°	Working Temperature: -10~45° C
Color Temperature: WH/NW/WW/RED/ GREEN/BLUE.	IP: 44
	Manner Of Packing: 50m/Roll



VMAX 220V ND-2835-120-IP44

Power: SMD 11W/m	Plate Sizes: 10mm
Specification: 2835 120LEDs/m	Surface Treatment: Cleae
Input Voltage: AC220-240V 50/60Hz	Life Span: 30000H
Luminous Flux: ≥1050Lm/m	Material: Cu+PC
Beam Angle: 120°	Working Temperature: -10~45° C
Color Temperature: WH/NW/WW/RED/ GREEN/BLUE/RGB.	IP: 44
	Manner Of Packing: 50m/Roll



MODI 220V N-5730-120-IP44

Power: SMD 7W/m	Plate Sizes: 10mm
Specification: 5730 120LEDs/m	Surface Treatment: Cleae
Input Voltage: AC220-240V 50/60Hz	Life Span: 30000H
Luminous Flux: ≥650Lm/m	Material: Cu+PC
Beam Angle: 120°	Working Temperature: -10~45° C
Color Temperature: WH/NW/WW/RED/ GREEN/BLUE/RGB.	IP: 44
	Manner Of Packing: 50m/Roll



VMAX 220V 5050-72-IP44

Power: SMD 8W/m	Plate Sizes: 10mm
Specification: 5050 72LEDs/m	Surface Treatment: Cleae
Input Voltage: AC220-240V 50/60Hz	Life Span: 25000H
Luminous Flux: ≥430Lm/m	Material: Cu+PC
Beam Angle: 120°	Working Temperature: -10~45° C
Color Temperature: WH/NW/WW/RED/ GREEN/BLUE/RGB.	IP: 44
	Manner Of Packing: 50m/Roll

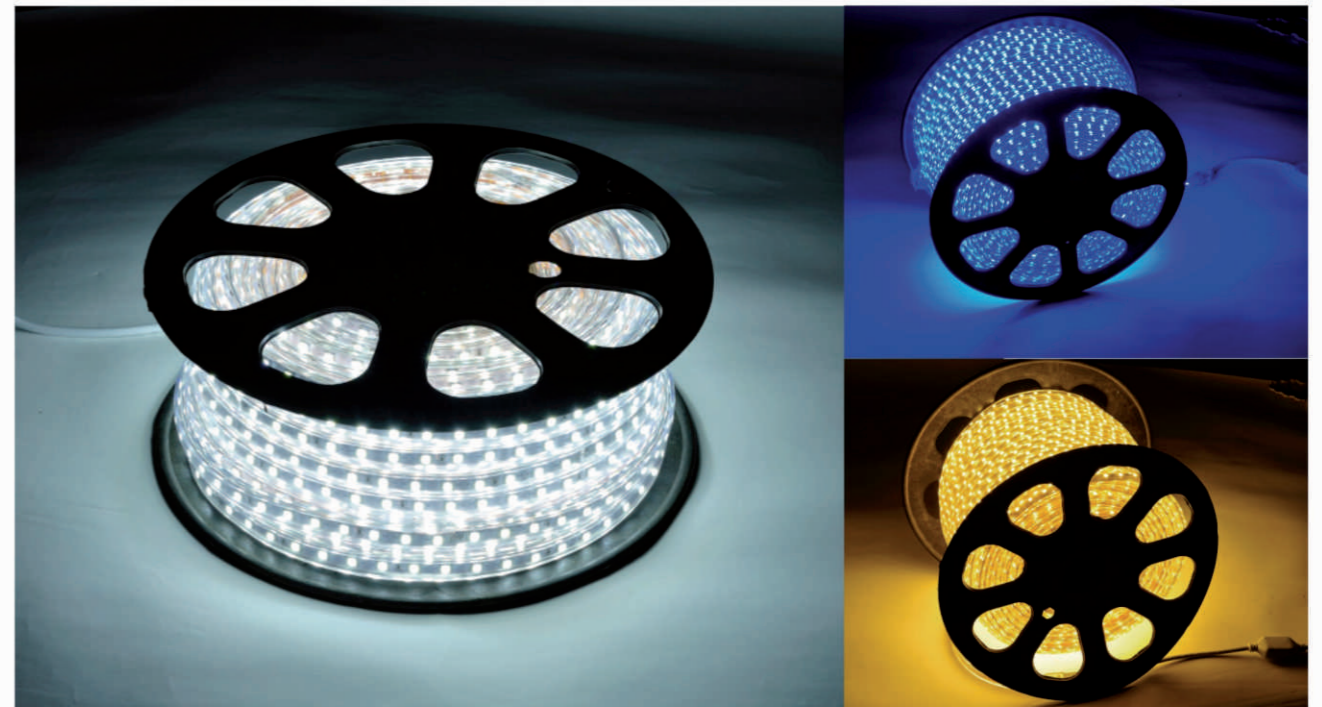



MODI 220V 5050-60-IP44

Power: SMD 10W/m	Plate Sizes: 10mm
Specification: 5050 60LEDs/m	Surface Treatment: Clear
Input Voltage: AC220-240V 50/60Hz	Life Span: 25000H
Luminous Flux: /	Material: Cu+PC
Beam Angle: 120°	Working Temperature: -10-45° C
Color Temperature: WH/NW/WW/RED/ GREEN/BLUE/RGB.	IP: 44
	Manner Of Packing: 50m/Roll



MODI 220V 5050-2*48-IP44

Power: SMD 13W/m	Plate Sizes: 12mm
Specification: 5050 96LEDs/m	Surface Treatment: Clear
Input Voltage: AC220-240V 50/60Hz	Life Span: 25000H
Luminous Flux: /	Material: Cu+PC
Beam Angle: 120°	Working Temperature: -10-45° C
Color Temperature: WH/NW/WW/RED/ GREEN/BLUE/RGB.	IP: 44
	Manner Of Packing: 50m/Roll

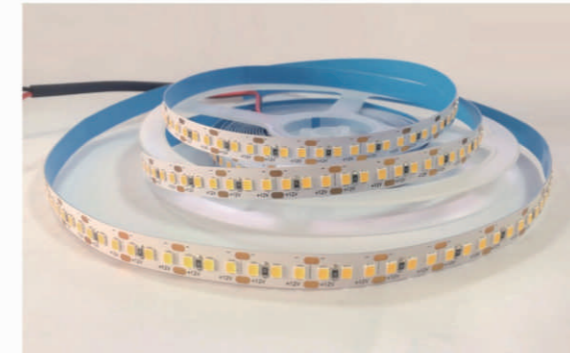
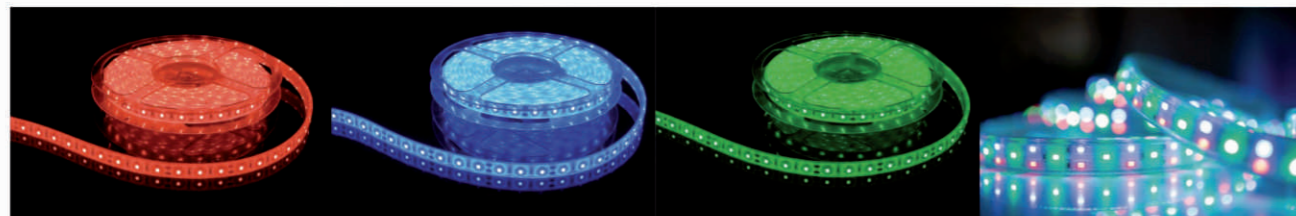

VMAX 12V 2835-168-IP20/65

Power: SMD 12W/m	Plate Sizes: 10mm
Specification: 2835 168LEDs/m	Surface Treatment: /
Input Voltage: DC 12V	Life Span: 30000H
Luminous Flux: ≥1000Lm/m	Material: Cu
Beam Angle: 120°	Working Temperature: -10-45° C
Color Temperature: WH/NW/WW/RED/ GREEN/BLUE/RGB.	IP: 20/65
	Manner Of Packing: 5m/Roll



MODI 12V/24V 5050-60-IP20

Power: SMD 6W/m	Plate Sizes: 10mm
Specification: 5050 60LEDs/m	Surface Treatment: /
Input Voltage: DC 12V/24V	Life Span: 25000H
Luminous Flux: ≥320Lm/m	Material: Cu+PC
Beam Angle: 120°	Working Temperature: -10-45° C
Color Temperature: WH/NW/WW/RED/ GREEN/BLUE/RGB.	IP: 20
	Manner Of Packing: 5m/Roll



MODI 12V 2835-120-IP20/65

Power: SMD 12W/m	Plate Sizes: 8mm
Specification: 2835 120LEDs/m	Surface Treatment: /
Input Voltage: DC 12V	Life Span: 30000H
Luminous Flux: ≥900Lm/m	Material: Cu
Beam Angle: 120°	Working Temperature: -10-45° C
Color Temperature: WH/NW/WW/RED/ GREEN/BLUE/RGB.	IP: 20
	Manner Of Packing: 5m/Roll





V.MAX 12V 2835-3H-IP66

Power: SMD 15W	Plate Sizes: 8mm
Input Voltage: DC 12V	Surface Treatment: WH
Luminous Flux: ≥95Lm	Life Span: 25000H
CRI: ≥70	Material: Cu
Beam Angle: 120°	Working Temperature: -10~50° C
Color Temperature: WH/NW/WW/RED/ GREEN/BLUE/RGB	IP: 66
	Body Size: 20pcs/line

V.MAX 12V 2835-3H-IP66

Power: SMD 15W	Plate Sizes: 8mm
Input Voltage: DC 12V	Surface Treatment: WH
Luminous Flux: ≥95Lm	Life Span: 25000H
CRI: ≥70	Material: Cu
Beam Angle: 120°	Working Temperature: -10~50° C
Color Temperature: WH/NW/WW/RED/ GREEN/BLUE/RGB	IP: 66
	Body Size: 20pcs/line



IP20 / IP54 / IP67
12V/24V LED Switching Power Supply

Parts:



Installation Construction:

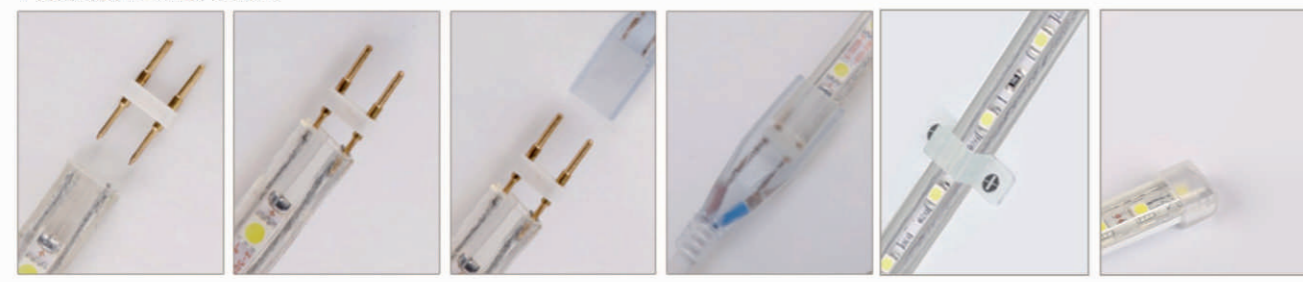

IP67 WATER PROOF 12V LED Switching Power Supply



V-12030C-12V

Power: 30W	Surface Treatment: SL
Input Voltage: AC220-240V 50/60Hz	Life Span: 15000H
Output Voltage: DC 12V 2.5A	Material: Alum
PF: >0.6	Working Temperature: -10~50° C
IP: 67	Body Size: 160*30*20mm

V-12120C-12V

Power: 120W	Surface Treatment: SL
Input Voltage: AC220-240V 50/60Hz	Life Span: 15000H
Output Voltage: DC 12V 10A	Material: Alum
PF: >0.6	Working Temperature: -10~50° C
IP: 67	Body Size: 250*71*44mm

Products list

Model No.	Power	Input Voltage	Output Voltage	IP	Body Size
V-12030C-12V	30W	AC220-240V 50/60Hz	DC 12V 2.5A	67	160x30x20mm
V-12060C-12V	60W	AC220-240V 50/60Hz	DC 12V 5A	67	150x65x50mm
V-12100C-12V	100W	AC220-240V 50/60Hz	DC 12V 8.5A	67	182x85x50mm
V-12120C-12V	120W	AC220-240V 50/60Hz	DC 12V 10A	67	250x71x44mm
V-12200C-12V	200W	AC220-240V 50/60Hz	DC 12V 16.6A	67	250x122x58mm
V-12400C-12V	400W	AC220-240V 50/60Hz	DC 12V 33.3A	67	250x122x58mm

IP54 RAINPROOF 12V LED Switching Power Supply

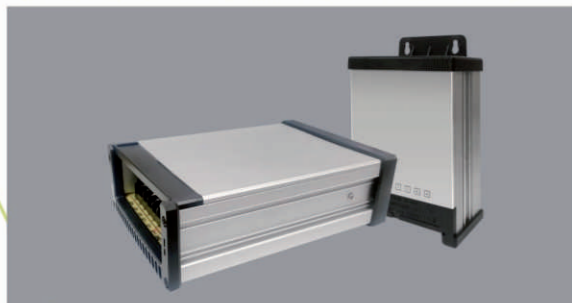

V-14060Y-12V

Power: 60W	Surface Treatment: GY
Input Voltage: AC220-240V 50/60Hz	Life Span: 30000H
Output Voltage: DC 12V 5A	Material: Alum+Fe
PF: >0.6	Working Temperature: -10~50° C
IP: 54	Body Size: 155*100*50mm

Products list

Model No.	Power	Input Voltage	Output Voltage	IP	Body Size
V-14060Y-12	60W	AC220-240V 50/60Hz	DC 12V 5A	54	136x75x40mm
V-14120Y-12	120W	AC220-240V 50/60Hz	DC 12V 10A	54	151x75x40mm
V-14200Y-12	200W	AC220-240V 50/60Hz	DC 12V 16.6A	54	143x93x50mm
V-14400Y-12	400W	AC220-240V 50/60Hz	DC 12V 33.3A	54	190x120x55mm

IP20 12V/24V LED Switching Power Supply

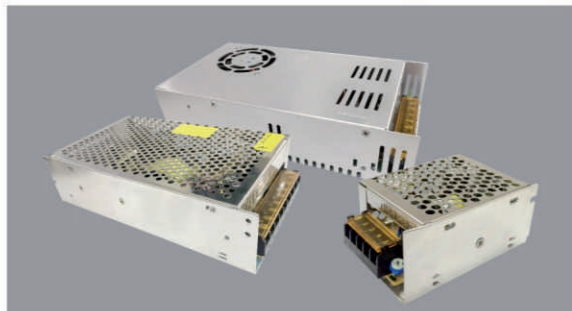

V-1760N-24V

Power: 60W	Surface Treatment: CH
Input Voltage: AC220-240V 50/60Hz	Life Span: 30000H
Output Voltage: DC 24V 2.5A	Material: Alum+Fe
PF: >0.6	Working Temperature: -10~45° C
IP: 20	Body Size: 110*78*37mm

Products list

Model No.	Power	Input Voltage	Output Voltage	IP	Body Size
V-1725N-12V	25W	AC220-240V 50/60Hz	DC 12V 2A	20	84x58x38mm
V-1760N-12V	60W	AC220-240V 50/60Hz	DC 12V 5A	20	110x78x37mm
V-17120N-12V	120W	AC220-240V 50/60Hz	DC 12V 10A	20	158x98x42mm
V-17150N-12V	150W	AC220-240V 50/60Hz	DC 12V 12.5A	20	200x98x42mm
V-17200N-12V	200W	AC220-240V 50/60Hz	DC 12V 16.6A	20	200x98x42mm
V-17250N-12V	250W	AC220-240V 50/60Hz	DC 12V 20.8A	20	200x110x52mm
V-17360N-12V	360W	AC220-240V 50/60Hz	DC 12V 30A	20	215x115x50mm
V-17500N-12V	500W	AC220-240V 50/60Hz	DC 12V 41.6A	20	216x113x50mm

Products list

Model No.	Power	Input Voltage	Output Voltage	IP	Body Size
V-1760N-24V	60W	AC220-240V 50/60Hz	DC 24V 2.5A	20	110x78x37mm
V-17200N-24V	200W	AC220-240V 50/60Hz	DC 24V 8.3A	20	200x98x42mm
V-17360N-24V	360W	AC220-240V 50/60Hz	DC 24V 15A	20	215x115x50mm

Products list

Model No.	Power	Input Voltage	Output Voltage	IP	Body Size
MD-1760N-12V	60W	AC220-240V 50/60Hz	DC 12V 5A	20	110x78x37mm
MD-17200N-12V	200W	AC220-240V 50/60Hz	DC 12V 16.6A	20	200x99x42mm
MD-17360N-12V	360W	AC220-240V 50/60Hz	DC 12V 30A	20	215x115x50mm



LED **Landscape Light**

Use the light and shadow features to present colorful decorative effect. Can be widely used in commercial hotel, entertainment space, home decoration, outdoor lighting, architecture landscape and other decorative environment.



Model No: V-P2050L	Surface Treatment: WH
Power: SMD 50W	Life Span: 30000H
Input Voltage: AC220-240V 50/60Hz	Material: Alum+Glass
Luminous Flux: 3500Lm	Working Temperature: -10~50° C
CRt: ≥80	IP: 66
Beam Angle: 95° /38°	Body Size: 245*193*65mm
Color Temperature: 6500/4000/3000K	Hole Size: /



V-P2050L

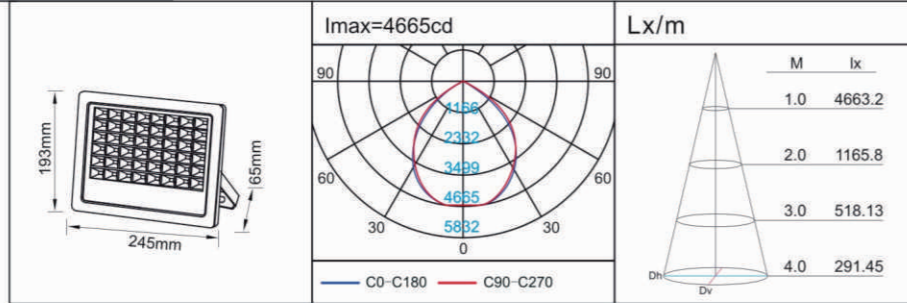

Products list

Model No.	Power	Luminous Flux	Beam angle	Surface	Body Size
V-P2050L	SMD 50W	3500Lm	60°/45°	WH	245x193x65mm
V-P20100S	SMD 100W	7000Lm	60°	WH	280x258x65mm
V-P20200L	SMD 200W	14000Lm	60°/45°	WH	460x280x65mm



Model No: V-P3860S	Surface Treatment: BK
Power: SMD 60W	Life Span: 30000H
Input Voltage: AC100-240V 50/60Hz	Material: Alum+Glass
Luminous Flux: 4800Lm	Working Temperature: -10~50° C
CRt: ≥80	IP: 66
Beam Angle: 75°	Body Size: 280*205*45mm
Color Temperature: 6500/4000/3000K	Hole Size: /



V-P3860S

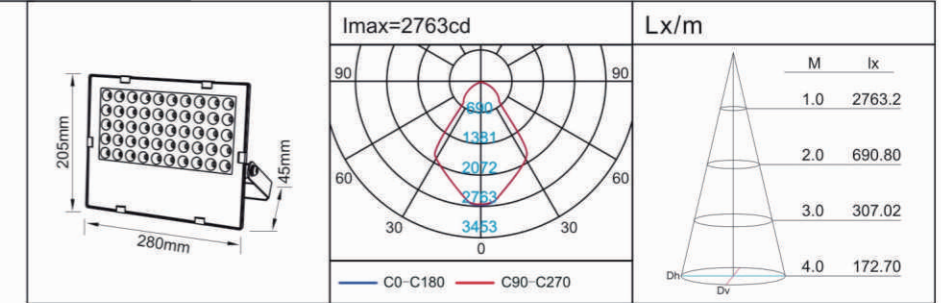

Products list

Model No.	Power	Luminous Flux	Beam angle	Surface	Body Size
V-P3820S	SMD 20W	1800Lm	75°	BK	185x150x45mm
V-P3860S	SMD 60W	4800Lm	75°	BK	280x205x45mm
V-P38120S	SMD 120W	8400Lm	60°	BK	335x285x55mm

Model No: V-P4150S	Surface Treatment: WH
Power: COB 50W	Life Span: 30000H
Input Voltage: AC220-240V 50/60Hz	Material: Alum+Glass
Luminous Flux: 4800Lm	Working Temperature: -10~50° C
CRt: ≥80	IP: 66
Beam Angle: 50°	Body Size: 222*202*105mm
Color Temperature: 6500/4000/3000K	Hole Size: /



V-P4150S

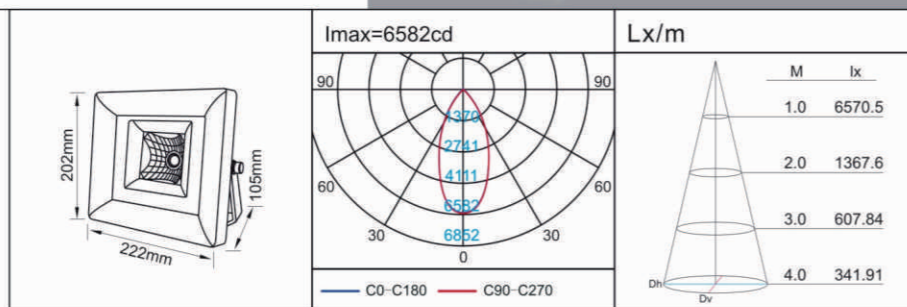

Products list

Model No.	Power	Luminous Flux	Beam angle	Surface	Body Size
V-P4150S	COB 50W	4800Lm	50°	WH	222x202x105mm
V-P41100S	COB 2x50W	10000Lm	50°	WH	300x272x115mm
V-P41200S	COB 4x50W	18000Lm	50°	WH	458x274x116mm

Model No: MD-P1950S	Surface Treatment: BK/PG
Power: COB 50W	Life Span: 25000H
Input Voltage: AC220-240V 50/60Hz	Material: Alum+Glass
Luminous Flux: 3500Lm	Working Temperature: -10~50° C
CRt: ≥70	IP: 65
Beam Angle: 90°	Body Size: 285*233*140mm
Color Temperature: 6500/4000/3000K	Hole Size: /



MD-P1950S

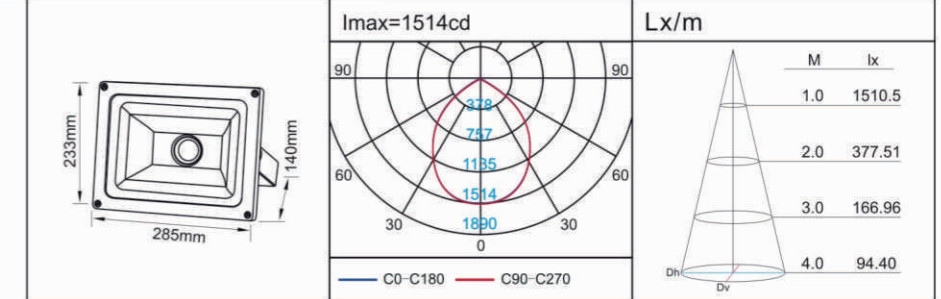

Products list

Model No.	Power	Luminous Flux	Beam angle	Surface	Body Size
MD-P1950S	COB 50W	3500Lm	90°	BK/PG	285x233x140mm
MD-P19100S	COB 2x50W	7000Lm	90°	BK/PG	317x252x145mm
MD-P19150S	COB 3x50W	10500Lm	90°	BK/PG	380x290x150mm
MD-P19200S	COB 4x50W	14000Lm	90°	BK/PG	390x350x155mm

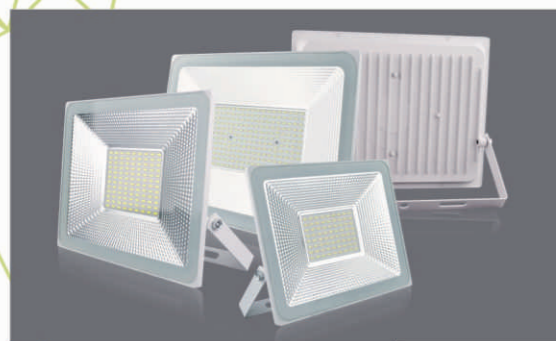

Model No: MD-P3760S-A	Surface Treatment: WH
Power: SMD 60W	Life Span: 25000H
Input Voltage: AC220-240V 50/60Hz	Material: Alum+Glass
Luminous Flux: 4800Lm	Working Temperature: -10~50° C
CRt: ≥70	IP: 66
Beam Angle: 140°	Body Size: 267*250*50mm
Color Temperature: 6500/4000/3000K	Hole Size: /

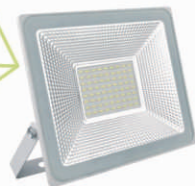

MD-P3760S-A

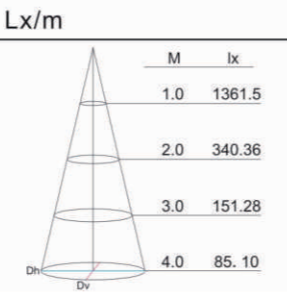
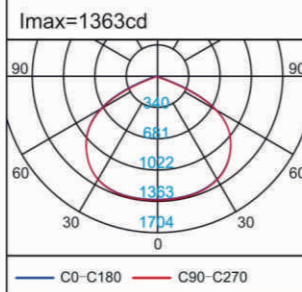
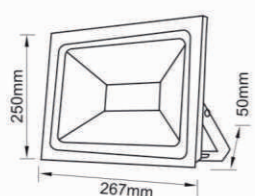

Products list

Model No.	Power	Luminous Flux	Beam angle	Surface	Body Size
MD-P3760S-A	SMD 60W	4800Lm	140°	WH	267x250x50mm
MD-P37100S-A	SMD 100W	8000Lm	140°	WH	315x270x50mm
MD-P37200S-A	SMD 200W	16000Lm	140°	WH	420x325x55mm



Model No: MD-P6850S	Surface Treatment: WH
Power: SMD 50W	Life Span: 25000H
Input Voltage: AC220-240V 50/60Hz	Material: Alum+Glass
Luminous Flux: 3500Lm	Working Temperature: -10~50° C
CRt: ≥70	IP: 65
Beam Angle: 70°	Body Size: 265*215*40mm
Color Temperature: 6500/4000/3000K	Hole Size: /



MD-P6850S

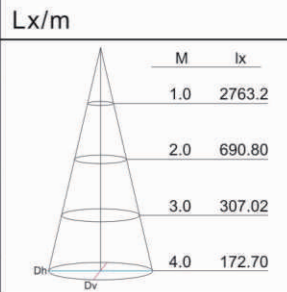
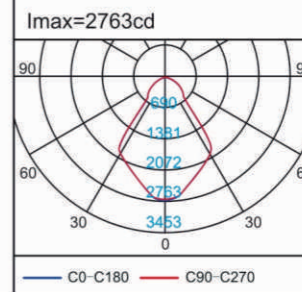

Products list

Model No.	Power	Luminous Flux	Beam angle	Surface	Body Size
MD-P6850S	SMD 50W	3500Lm	70°	WH	265x215x40mm
MD-P68100S	SMD 100W	8500Lm	80°	WH	285x335x45mm
MD-P68200S	SMD 200W	15000Lm	80°	WH	525x335x45mm

Model No: MD-P3760S	Surface Treatment: BK
Power: SMD 60W	Life Span: 25000H
Input Voltage: AC220-240V 50/60Hz	Material: Alum+Glass
Luminous Flux: 4800Lm	Working Temperature: -10~50° C
CRt: ≥70	IP: 66
Beam Angle: 140°	Body Size: 267*250*50mm
Color Temperature: 6500/4000/3000K	Hole Size: /



MD-P3760S

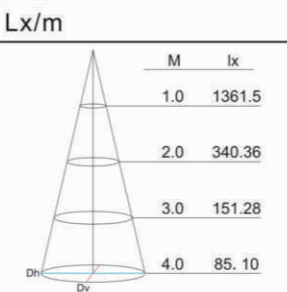
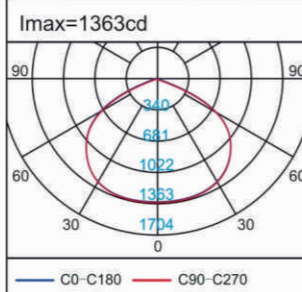
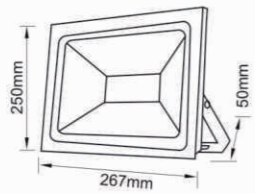

Products list

Model No.	Power	Luminous Flux	Beam angle	Surface	Body Size
MD-P3760S	SMD 60W	4800Lm	140°	BK	267x250x50mm
MD-P37100S	SMD 100W	8000Lm	140°	BK	315x270x50mm
MD-P37200S	SMD 200W	16000Lm	140°	BK	420x325x55mm
MD-P37300S	SMD 300W	18000Lm	140°	BK	470x355x75mm
MD-P37400S	SMD 400W	20000Lm	140°	BK	500x385x80mm

Item NO: V-SL1050L	Surface Treatment: BK
Power: SMD 50W	Life Span: 30000H
Input Voltage: AC100-240V 50/60Hz	Material: Alum+GLASS
Luminous Flux: 5000Lm	Working Temperature: -10~50° C
CRt: ≥70	IP: 65
Beam Angle: 120°	Product Size: 425*180*85mm
Color Temperature: 6500/4000/3000K	Hole Size: /



V-SL1050L

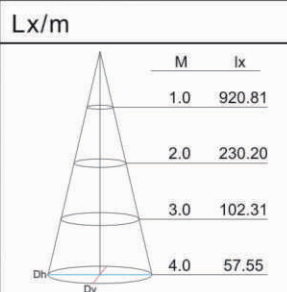
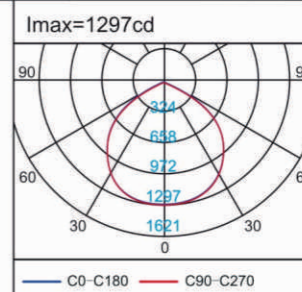
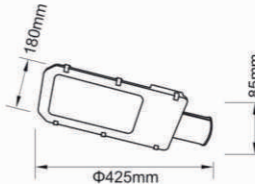

Products list

Item NO.	Power	Luminous Flux	Beam angle	Surface	Specification
V-SL1050L	SMD 50W	5000Lm	120°	BK	425x180x85mm
V-SL10100L	SMD 100W	10000Lm	120°	BK	510x220x85mm



Model No: MD-B0103	Surface Treatment: BK
Power: COB 3W	Life Span: 25000H
Input Voltage: AC220-240V 50/60Hz	Material: Alum+ABC+Glass
Luminous Flux: 240Lm	Working Temperature: -10-50° C
CRt: ≥70	IP: 65
Beam Angle: 30°	Body Size: Φ65*80mm
Color Temperature: 6500/4000/3000K/RGB.	Hole Size: /



MD-B0103

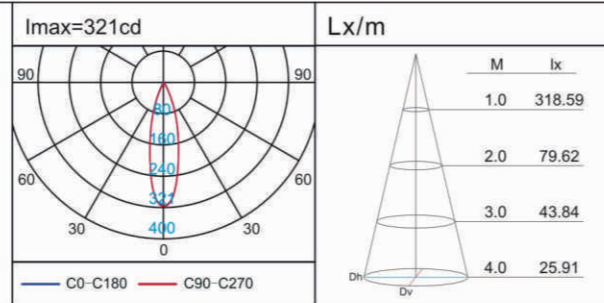
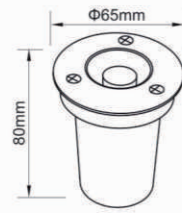

Products list

Model No.	Power	Luminous Flux	Beam angle	Surface	Body Size
MD-B0103	COB 3W	240Lm	30°	BK	Φ65x80mm
MD-B0106	COB 6W	520Lm	30°	BK	Φ80x90mm
MD-B0109	COB 9W	810Lm	30°	BK	Φ100x90mm
MD-B01012	COB 12W	960Lm	30°	BK	Φ120x90mm
MD-B01018	COB 18W	1500Lm	30°	BK	Φ150x90mm



Model No: MD-BL1424R	Surface Treatment: BK
Power: High Power 24*1W	Life Span: 25000H
Input Voltage: AC100-240V 50/60Hz	Material: Alum+ABC+Glass
Luminous Flux: 1700Lm	Working Temperature: -10-50° C
CRt: ≥70	IP: 67
Beam Angle: 30°	Body Size: Φ250*90mm
Color Temperature: 6500/4000/3000K/RGB.	Hole Size: Φ200mm

Model No: MD-BL1436R	Surface Treatment: BK
Power: High Power 36*1W	Life Span: 25000H
Input Voltage: AC100-240V 50/60Hz	Material: Alum+ABC+Glass
Luminous Flux: 2600Lm	Working Temperature: -10-50° C
CRt: ≥70	IP: 67
Beam Angle: 30°	Body Size: Φ300*90mm
Color Temperature: 6500/4000/3000K/RGB.	Hole Size: Φ255mm

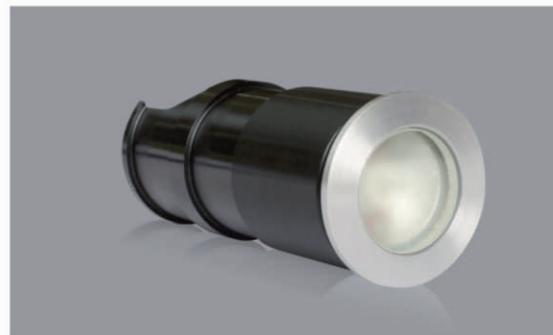

Model No: V-1102	Surface Treatment: BK
Power: High power 1W	Life Span: 30000H
Input Voltage: AC100-240V 50/60Hz	Material: Alum+PC
Luminous Flux: 65Lm	Working Temperature: -10-60° C
CRt: ≥70	IP: 65
Beam Angle: 45°	Body Size: Φ42*96mm
Color Temperature: 6500/4000/3000K	Hole Size: Φ42mm

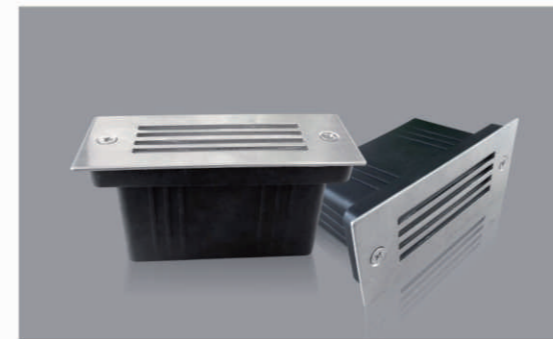

Model No: V-BL0203L	Surface Treatment: BK
Power: SMD 3W	Life Span: 30000H
Input Voltage: AC220-240V 50/60Hz	Material: Alum+Iron+Glass
Luminous Flux: 40Lm	Working Temperature: -10-50° C
CRt: ≥70	IP: 65
Beam Angle: 30°	Body Size: 112*45*56mm
Color Temperature: 6500/4000/3000K/RGB.	Hole Size: /

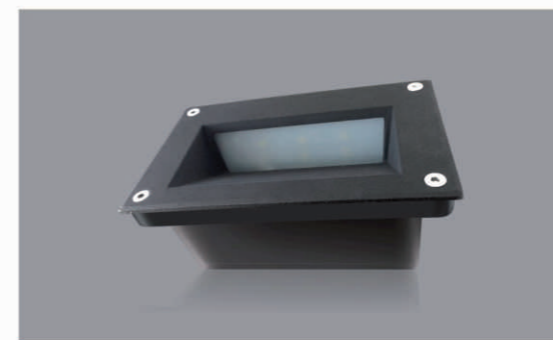

Model No: V-WL17603L	Surface Treatment: BK
Power: SMD 3W	Life Span: 30000H
Input Voltage: AC220-240V 50/60Hz	Material: Alum+Iron+Glass
Luminous Flux: 210Lm	Working Temperature: -10-50° C
CRt: ≥70	IP: 65
Beam Angle: 30°	Body Size: 162*98*65mm
Color Temperature: 6500/4000/3000K/RGB.	Hole Size: /

Model No: MD-IL0205R	Surface Treatment: BK
Power: COB 5W	Life Span: 25000H
Input Voltage: AC100-240V 50/60Hz	Material: Alum+Fe+PC
Luminous Flux: 420Lm	Working Temperature: -10-50° C
CRt: ≥70	IP: 65
Beam Angle: 30°	Body Size: Φ72*282mm
Color Temperature: 6500/4000/3000K/RGB.	Hole Size: /



MD-IL0205R

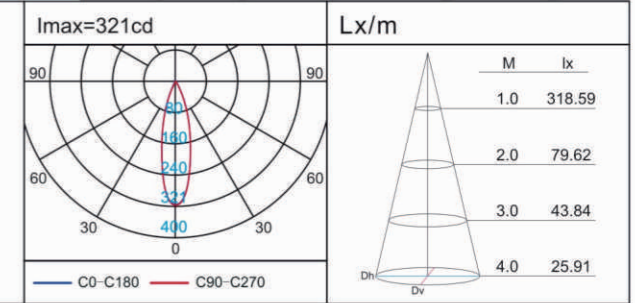
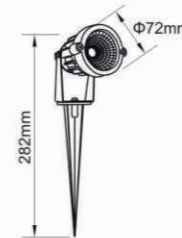

Products list

Model No.	Power	Luminous Flux	Beam angle	Surface	Body Size
MD-IL0205R	COB 5W	420Lm	30°	BK	Φ72x282mm
MD-IL0209R-B	COB 9W	550Lm	30°	BK	Φ60x260mm
MD-IL0309R	COB 9W	630Lm	30°	BK	Φ105x380mm



Model No: MD-WL15708R-B	Surface Treatment: BK/WH/GY/AB
Power: 8W	Life Span: 25000H
Input Voltage: AC220-240V 50/60Hz	Material: Alum+Acrylic
Luminous Flux: 550Lm	Working Temperature: -10~50° C
CRt: ≥70	IP: 65
Color Temperature: 6500/4000/3000K	Body Size: 150*90*140mm

Model No: MD-WL15708R-2B	Surface Treatment: BK/WH/GY/AB
Power: 2*8W	Life Span: 25000H
Input Voltage: AC220-240V 50/60Hz	Material: Alum+Acrylic
Luminous Flux: 1100Lm	Working Temperature: -10~50° C
CRt: ≥70	IP: 65
Color Temperature: 6500/4000/3000K	Body Size: 150*90*200mm



Model No: MD-WL15708R-A	Surface Treatment: BK/WH/GY/AB
Power: 8W	Life Span: 25000H
Input Voltage: AC220-240V 50/60Hz	Material: Alum+Acrylic
Luminous Flux: 550Lm	Working Temperature: -10~50° C
CRt: ≥70	IP: 65
Color Temperature: 6500/4000/3000K	Body Size: 150*90*140mm

Model No: MD-WL15708R-2A	Surface Treatment: BK/WH/GY/AB
Power: 2*8W	Life Span: 25000H
Input Voltage: AC220-240V 50/60Hz	Material: Alum+Acrylic
Luminous Flux: 1100Lm	Working Temperature: -10~50° C
CRt: ≥70	IP: 65
Color Temperature: 6500/4000/3000K	Body Size: 150*90*200mm

Model No: MD-C2208R-A	Surface Treatment: BK/WH/GY/AB
Power: SMD 8W	Life Span: 25000H
Input Voltage: AC220-240V 50/60Hz	Material: Alum+Acrylic
Luminous Flux: 550Lm	Working Temperature: -10~50° C
CRt: ≥70	IP: 65
Color Temperature: 6500/4000/3000K/RGB.	Body Size: φ135*300mm

Model No: MD-C2208R-B	Surface Treatment: BK/WH/GY/AB
Power: SMD 8W	Life Span: 25000H
Input Voltage: AC220-240V 50/60Hz	Material: Alum+Acrylic
Luminous Flux: 550Lm	Working Temperature: -10~50° C
CRt: ≥70	IP: 65
Color Temperature: 6500/4000/3000K/RGB.	Body Size: φ135*1000mm



Model No: MD-WL15800R	Surface Treatment: BK/WH/GY/AB
Power: Suitable all of E27 Lamp holder	Working Temperature: -10~50° C
Input Voltage: AC220-240V 50/60Hz	IP: 65
Material: Alum+Glass+Iron	Body Size: 220*95*240mm

Model No: MD-WL15800R-2	Surface Treatment: BK/WH/GY/AB
Power: Suitable all of E27 Lamp holder	Working Temperature: -10~50° C
Input Voltage: AC220-240V 50/60Hz	IP: 65
Material: Alum+Glass+Iron	Body Size: 220*95*390mm

Model No: MD-C2300R-A	Surface Treatment: BK/WH/GY/AB
Power: Suitable all of E27 Lamp holder	Working Temperature: -10~50° C
Input Voltage: AC220-240V 50/60Hz	IP: 65
Material: Alum+Glass+Iron	Body Size: φ155*300mm

Model No: MD-C2300R-B	Surface Treatment: BK/WH/GY/AB
Power: Suitable all of E27 Lamp holder	Working Temperature: -10~50° C
Input Voltage: AC220-240V 50/60Hz	IP: 65
Material: Alum+Glass+Iron	Body Size: φ155*1000mm



Model No: V-C1512C	Surface Treatment: GY
Power: SMD 12W	Life Span: 25000H
Input Voltage: AC220-240V 50/60Hz	Material: Alum+PC
Luminous Flux: 800Lm	Working Temperature: -10~50° C
CRt: ≥80	IP: 65
Color Temperature: 6500/4000/3000K/RGB.	Body Size: φ145*800mm

Model No: V-C1408C-A	Surface Treatment: GY
Power: SMD 8W	Life Span: 25000H
Input Voltage: AC220-240V 50/60Hz	Material: Alum+Acrylic
Luminous Flux: 370Lm	Working Temperature: -10~50° C
CRt: ≥80	IP: 65
Color Temperature: 6500/4000/3000K/RGB.	Body Size: φ165*800mm



Model No: V-WL9312C	Surface Treatment: GY
Power: SMD 12W	Life Span: 30000H
Input Voltage: AC220-240V 50/60Hz	Material: Alum+PC
Luminous Flux: 1100Lm	Working Temperature: -10~50° C
CRt: ≥80	IP: 65
Beam Angle: 120°	Body Size: φ248*274mm
Color Temperature: 6500/4000/3000K	Hole Size: /

Model No: V-C0212C1	Surface Treatment: GY
Power: SMD 12W	Life Span: 30000H
Input Voltage: AC220-240V 50/60Hz	Material: Alum+PC
Luminous Flux: 1200Lm	Working Temperature: -10~50° C
CRt: ≥80	IP: 65
Beam Angle: 120°	Body Size: φ248*295mm
Color Temperature: 6500/4000/3000K	Hole Size: /

Model No: V-C0412C1	Surface Treatment: GY
Power: SMD 12W	Life Span: 30000H
Input Voltage: AC220-240V 50/60Hz	Material: Alum+PC
Luminous Flux: 1250Lm	Working Temperature: -10~50° C
CRt: ≥80	IP: 65
Beam Angle: 120°	Body Size: φ248*800mm
Color Temperature: 6500/4000/3000K	Hole Size: /

Model No: V-C0512C1-3	Surface Treatment: GY
Power: SMD 3*12W	Life Span: 30000H
Input Voltage: AC220-240V 50/60Hz	Material: Alum+PC
Luminous Flux: 2500Lm	Working Temperature: -10~50° C
CRt: ≥80	IP: 65
Beam Angle: 120°	Body Size: 625*575*2500mm
Color Temperature: 6500/4000/3000K	Hole Size: /



LED Wall Light

Can freely collocate the combination according to different environment and use requirements, use the light and shadow features to present colorful decorative effect. Can be widely used in gardens, outdoor residential areas, walkways & passages, driveways, fountains, lawns, entrance, patio or terrace and similar environments.



Model No: V-WL9112S-1	Surface Treatment: GY/BK
Power: COB 12W	Life Span: 30000H
Input Voltage: AC220-240V 50/60Hz	Material: Alum+Glass
Luminous Flux: 900Lm	Working Temperature: -10~50° C
CRI: ≥80	IP: 65
Color Temperature: 6500/4000/3000K	Body Size: 149*119*161mm

Model No: V-WL9112S-2	Surface Treatment: GY/BK
Power: COB 2*12W	Life Span: 30000H
Input Voltage: AC220-240V 50/60Hz	Material: Alum+Glass
Luminous Flux: 1900Lm	Working Temperature: -10~50° C
CRI: ≥80	IP: 65
Color Temperature: 6500/4000/3000K	Body Size: 214*118*149mm



Model No: V-WL9120C-1	Surface Treatment: GY/BK
Power: COB 20W	Life Span: 30000H
Input Voltage: AC220-240V 50/60Hz	Material: Alum+Glass
Luminous Flux: 1700Lm	Working Temperature: -10~50° C
CRI: ≥80	IP: 65
Color Temperature: 6500/4000/3000K	Body Size: 184*146*201mm

Model No: V-WL9115C-2	Surface Treatment: GY/BK
Power: COB 2*15W	Life Span: 30000H
Input Voltage: AC220-240V 50/60Hz	Material: Alum+Glass
Luminous Flux: 2400Lm	Working Temperature: -10~50° C
CRI: ≥80	IP: 65
Color Temperature: 6500/4000/3000K	Body Size: 184*146*303mm



Model No: V-WL9608R-1	Surface Treatment: GY/BK
Power: COB 8W	Life Span: 30000H
Input Voltage: AC220-240V 50/60Hz	Material: Alum+PC
Luminous Flux: 560Lm	Working Temperature: -10~50° C
CRI: ≥80	IP: 65
Color Temperature: 6500/4000/3000K	Body Size: 140*129*115mm

Model No: V-WL9608R-2	Surface Treatment: GY/BK
Power: COB 2*8W	Life Span: 30000H
Input Voltage: AC220-240V 50/60Hz	Material: Alum+PC
Luminous Flux: 1100Lm	Working Temperature: -10~50° C
CRI: ≥80	IP: 65
Color Temperature: 6500/4000/3000K	Body Size: 140*129*170mm



Model No: V-WL15503C-2A	Surface Treatment: WH+GL
Power: COB 2*3W	Life Span: 30000H
Input Voltage: AC100-240V 50/60Hz	Material: Alum+Glass
Luminous Flux: 420Lm	Working Temperature: -10~50° C
CRI: ≥70	IP: 65
Color Temperature: 6500/4000/3000K	Body Size: 70*60*130mm

Model No: V-WL15505C-2A	Surface Treatment: WH+GL
Power: COB 2*5W	Life Span: 30000H
Input Voltage: AC100-240V 50/60Hz	Material: Alum+Glass
Luminous Flux: 700Lm	Working Temperature: -10~50° C
CRI: ≥70	IP: 65
Color Temperature: 6500/4000/3000K	Body Size: 107*100*200mm



Model No: V-WL9508C-2	Surface Treatment: GY/BK
Power: COB 2*8W	Life Span: 30000H
Input Voltage: AC220-240V 50/60Hz	Material: Alum+Glass
Luminous Flux: 960Lm	Working Temperature: -10~50° C
CRI: ≥80	IP: 65
Color Temperature: 6500/4000/3000K	Body Size: 120*136*263mm

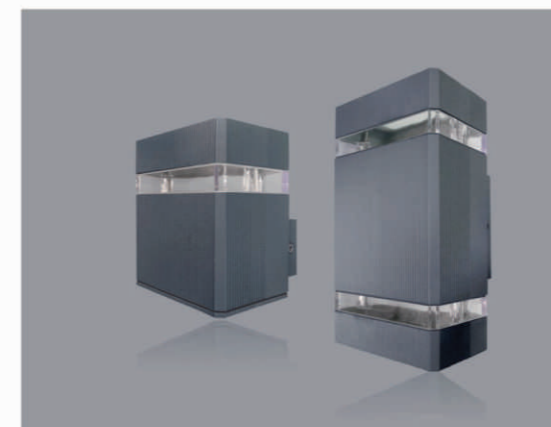

Model No: V-WL9006S-1	Surface Treatment: GY/BK
Power: COB 6W	Life Span: 30000H
Input Voltage: AC220-240V 50/60Hz	Material: Alum+Acrylic
Luminous Flux: 400Lm	Working Temperature: -10~50° C
CRI: ≥80	IP: 65
Color Temperature: 6500/4000/3000K	Body Size: 110*92*119mm

Model No: V-WL9006S-2	Surface Treatment: GY/BK
Power: COB 2*6W	Life Span: 30000H
Input Voltage: AC220-240V 50/60Hz	Material: Alum+Acrylic
Luminous Flux: 780Lm	Working Temperature: -10~50° C
CRI: ≥80	IP: 65
Color Temperature: 6500/4000/3000K	Body Size: 110*92*197mm

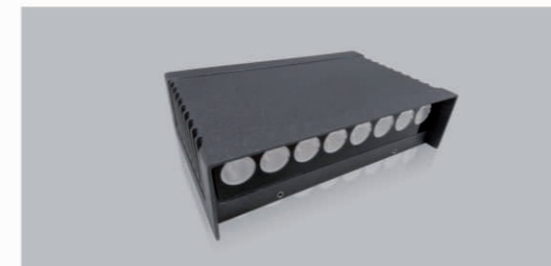

Model No: V-WL9408S-1/2	Surface Treatment: GY/BK
Power: High power 8W/2*8W	Life Span: 30000H
Input Voltage: AC220-240V 50/60Hz	Material: Alum+Glass
Luminous Flux: 900Lm/1800Lm	Working Temperature: -10~50° C
CRI: ≥80	IP: 65
Color Temperature: 6500/4000/3000K	Body Size: 202*130*55mm

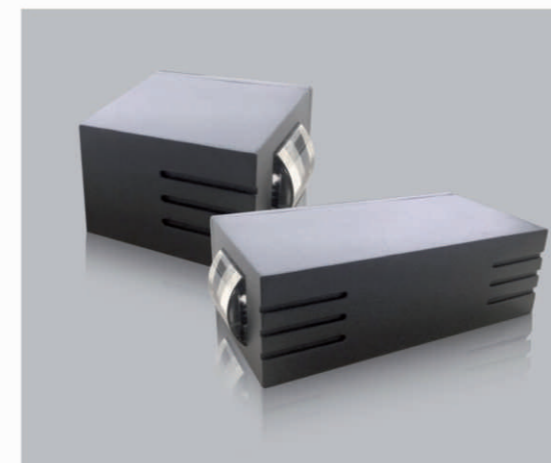

Model No: V-WL3803L	Surface Treatment: BK/GY
Power: 3W	Life Span: 30000H
Input Voltage: AC220-240V 50/60Hz	Material: Alum
Luminous Flux: 80Lm	Working Temperature: -10~50° C
CRI: ≥70	IP: 65
Color Temperature: 6500/4000/3000K	Body Size: 90*65*90mm

Model No: V-WL3803L-2	Surface Treatment: BK/GY
Power: 2*3W	Life Span: 30000H
Input Voltage: AC220-240V 50/60Hz	Material: Alum
Luminous Flux: 110Lm	Working Temperature: -10~50° C
CRI: ≥70	IP: 65
Color Temperature: 6500/4000/3000K	Body Size: 90*65*160mm



Model No: V-WL16710R	Surface Treatment: BK
Power: SMD 10W	Life Span: 30000H
Input Voltage: AC220-240V 50/60Hz	Material: Alum+PC
Luminous Flux: 420Lm	Working Temperature: -10-50° C
CR _a ≥70	IP: 65
Color Temperature: 6500/4000/3000K	Body Size: 274*183*88mm



Model No: V-WL16710S	Surface Treatment: BK
Power: SMD 10W	Life Span: 30000H
Input Voltage: AC220-240V 50/60Hz	Material: Alum+PC
Luminous Flux: 420Lm	Working Temperature: -10-50° C
CR _a ≥70	IP: 65
Color Temperature: 6500/4000/3000K	Body Size: 274*183*88mm



Model No: MD-WL18415R-A/B/C	Surface Treatment: WH/BK
Power: SMD 15W	Life Span: 25000H
Input Voltage: AC220-240V 50/60Hz	Material: Alum+PC
Luminous Flux: 1500Lm	Working Temperature: -10-45° C
CR _a ≥75	IP: 65
Color Temperature: 7500/4000/3000K	Body Size: φ215*115*60mm

Model No: MD-WL18420R-A/B/C	Surface Treatment: WH/BK
Power: SMD 20W	Life Span: 25000H
Input Voltage: AC220-240V 50/60Hz	Material: Alum+PC
Luminous Flux: 2000Lm	Working Temperature: -10-45° C
CR _a ≥75	IP: 65
Color Temperature: 7500/4000/3000K	Body Size: φ270*142*78mm



Model No: MD-WL18415R-D	Surface Treatment: WH/BK
Power: SMD 15W	Life Span: 25000H
Input Voltage: AC220-240V 50/60Hz	Material: Alum+PC
Luminous Flux: 1500Lm	Working Temperature: -10-45° C
CR _a ≥75	IP: 65
Color Temperature: 7500/4000/3000K	Body Size: φ170*60mm

Model No: MD-WL18420R-D	Surface Treatment: WH/BK
Power: SMD 20W	Life Span: 25000H
Input Voltage: AC220-240V 50/60Hz	Material: Alum+PC
Luminous Flux: 2000Lm	Working Temperature: -10-45° C
CR _a ≥75	IP: 65
Color Temperature: 7500/4000/3000K	Body Size: φ225*66mm

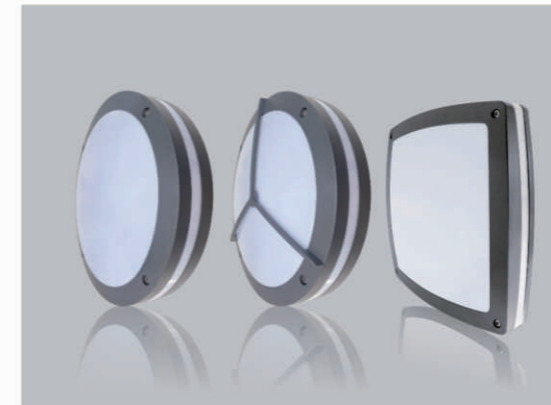

Model No: V-WL9824R-A/B	Surface Treatment: GY/BK
Power: SMD 24W	Life Span: 30000H
Input Voltage: AC100-240V 50/60Hz	Material: Alum+PC
Luminous Flux: 600Lm	Working Temperature: -10-50° C
CR _a ≥80	IP: 65
Color Temperature: 6500/4000/3000K	Body Size: φ300*85mm

Model No: V-WL9824S-A	Surface Treatment: GY/BK
Power: SMD 24W	Life Span: 30000H
Input Voltage: AC100-240V 50/60Hz	Material: Alum+PC
Luminous Flux: 600Lm	Working Temperature: -10-50° C
CR _a ≥80	IP: 65
Color Temperature: 6500/4000/3000K	Body Size: 300*300*85mm



Model No: MD-WL16803C	Surface Treatment: GY/BK
Power: 3W	Life Span: 30000H
Input Voltage: AC220-240V 50/60Hz	Material: Alum
Luminous Flux: 180Lm	Working Temperature: -10-50° C
CR _a ≥80	IP: 65
Color Temperature: 6500/4000/3000K	Body Size: 65*113*120mm

Model No: MD-WL16803C-2	Surface Treatment: GY/BK
Power: 2*3W	Life Span: 30000H
Input Voltage: AC220-240V 50/60Hz	Material: Alum
Luminous Flux: 350Lm	Working Temperature: -10-50° C
CR _a ≥80	IP: 65
Color Temperature: 6500/4000/3000K	Body Size: 65*113*163mm



Model No: MD-WL16900S	Surface Treatment: BK
Power: Suitable all of G410 Lamp holder	Working Temperature: -10-50° C
Input Voltage: AC220-240V 50/60Hz	IP: 65
Material: Alum+Glass	Body Size: 90*65*90mm

Model No: MD-WL16900L-2	Surface Treatment: BK
Power: Suitable all of G410 Lamp holder	Working Temperature: -10-50° C
Input Voltage: AC220-240V 50/60Hz	IP: 65
Material: Alum+Glass	Body Size: 90*65*160mm

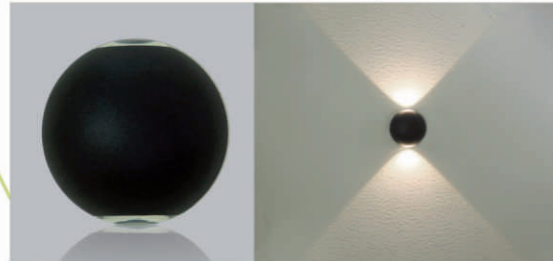

Model No: V-WL16603R-2	Surface Treatment: BK/WH
Power: 2*3W	Life Span: 30000H
Input Voltage: AC220-240V 50/60Hz	Material: Alum+Glass
Luminous Flux: ≥420Lm	Working Temperature: -10-50° C
CRt: ≥80	IP: 65
Color Temperature: 6500/4000/3000K	Body Size: φ95*86mm

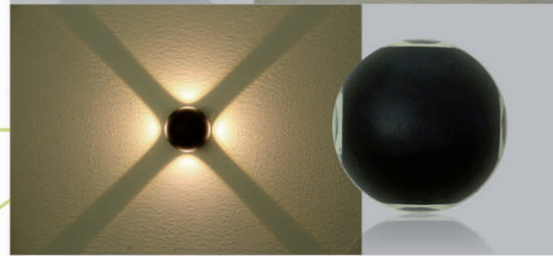

Model No: V-WL16603R-4	Surface Treatment: BK/WH
Power: 4*3W	Life Span: 30000H
Input Voltage: AC220-240V 50/60Hz	Material: Alum+Glass
Luminous Flux: ≥950Lm	Working Temperature: -10-50° C
CRt: ≥80	IP: 65
Color Temperature: 6500/4000/3000K	Body Size: φ95*86mm

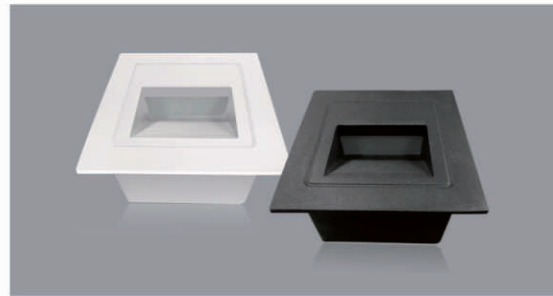

Model No: V-WL17103S	Surface Treatment: WH/BK
Power: SMD 3W	Life Span: 30000H
Input Voltage: AC220-240V 50/60Hz	Working Temperature: -10-50° C
Luminous Flux: ≥50Lm	IP: 65
CRt: ≥80	Body Size: 84*84*50mm
Color Temperature: 6500/4000/3000K	Hole size: 70*70mm

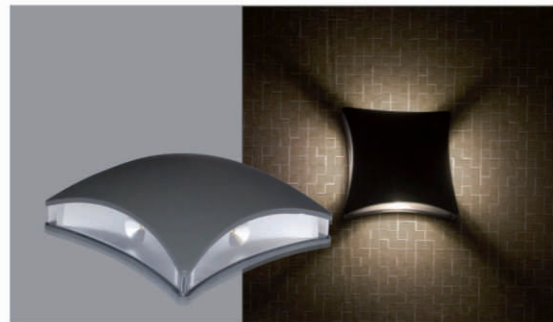

Model No: V-WL1208S	Surface Treatment: GY
Power: 4*2W	Life Span: 30000H
Input Voltage: AC220-240V 50/60Hz	Material: Alum+PC
Luminous Flux: ≥50Lm	Working Temperature: -10-50° C
CRt: ≥80	IP: 65
Color Temperature: 6500/4000/3000K	Body Size: 205*205*73mm

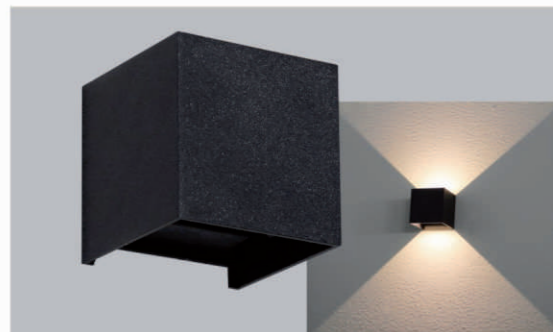

Model No: V-WL17003S-2	Surface Treatment: BK/WH
Power: 2*3W	Life Span: 30000H
Input Voltage: AC220-240V 50/60Hz	Material: Alum
Luminous Flux: 350Lm	Working Temperature: -10-50° C
CRt: ≥70	IP: 65
Color Temperature: 6500/4000/3000K	Body Size: 100*100*100mm



Model No: V-WL19106R/S	Surface Treatment: BK/WH
Power: 6W	Life Span: 30000H
Input Voltage: AC220-240V 50/60Hz	Material: Alum+Glass
Luminous Flux: /	Working Temperature: -10-50° C
CRt: ≥70	IP: 65
Color Temperature: 6500/4000/3000K	Body Size: 115*36mm

Model No: V-WL19206L	Surface Treatment: BK/WH
Power: 6W	Life Span: 30000H
Input Voltage: AC220-240V 50/60Hz	Material: Alum+Glass
Luminous Flux: /	Working Temperature: -10-50° C
CRt: ≥70	IP: 65
Color Temperature: 6500/4000/3000K	Body Size: 225*80*32mm



Model No: MD-WL16304S	Surface Treatment: WH/BK
Power: COB 4W	Life Span: 25000H
Input Voltage: AC220-240V 50/60Hz	Material: Alum+Glass
Luminous Flux: 170Lm	Working Temperature: -10-50° C
CRt: ≥70	IP: 65
Color Temperature: 6500/4000/3000K	Body Size: 79*83*69mm

Model No: MD-WL16303L-2	Surface Treatment: WH/BK
Power: COB 2*3W	Life Span: 25000H
Input Voltage: AC220-240V 50/60Hz	Material: Alum+Glass
Luminous Flux: 300Lm	Working Temperature: -10-50° C
CRt: ≥70	IP: 65
Color Temperature: 6500/4000/3000K	Body Size: 143*83*69mm



Model No: MD-WL16503S-4	Surface Treatment: GY
Power: 4*3W	Life Span: 25000H
Input Voltage: AC220-240V 50/60Hz	Material: Alum+Acrylic
Luminous Flux: 950Lm	Working Temperature: -10-50° C
CRt: ≥70	IP: 65
Color Temperature: 6500/4000/3000K	Body Size: 93*93*78mm



Model No: MD-WL18902L-4	Surface Treatment: BK/WH
Power: High power 4*2W	Life Span: 25000H
Input Voltage: AC100-240V 50/60Hz	Material: Alum+Acrylic
Luminous Flux: 770Lm	Working Temperature: -10~50° C
CRt: ≥70	IP: 65
Color Temperature: 6500/4000/3000K/RGB	Body Size: 120*38*95mm

Model No: MD-WL18902L-6	Surface Treatment: BK/WH
Power: High power 6*2W	Life Span: 25000H
Input Voltage: AC100-240V 50/60Hz	Material: Alum+Acrylic
Luminous Flux: 1100Lm	Working Temperature: -10~50° C
CRt: ≥70	IP: 65
Color Temperature: 6500/4000/3000K/RGB	Body Size: 185*38*95mm

Model No: MD-WL18902L-8	Surface Treatment: BK/WH
Power: High power 8*2W	Life Span: 25000H
Input Voltage: AC100-240V 50/60Hz	Material: Alum+Acrylic
Luminous Flux: 1500Lm	Working Temperature: -10~50° C
CRt: ≥70	IP: 65
Color Temperature: 6500/4000/3000K/RGB	Body Size: 220*50*96mm

Model No: MD-WL18902L-12	Surface Treatment: BK/WH
Power: High power 12*2W	Life Span: 25000H
Input Voltage: AC100-240V 50/60Hz	Material: Alum+Acrylic
Luminous Flux: 2200Lm	Working Temperature: -10~50° C
CRt: ≥70	IP: 65
Color Temperature: 6500/4000/3000K/RGB	Body Size: 320*60*96mm



LED Emergency Light

this kind of products are widely applied to Airport, Car Park, Church, Cinema, Gallery, Garage, Hospital, Kitchen, Meeting Room, Museum, Office, Restaurant, School, Shopping Mall and so on,

V.MAX[®] LED Emergency Light

LED Emergency Sign Light



Model No: V-ELM2103L	Surface Treatment: SL
Power: 3W	Life Span: 30000H
Charging Time: >24 Hours	Material: Alum+Acrylic
Working Time: >2Hours	Working Temperature: -10-45° C
Batteries: 12V AA 800mAh	IP: 20
Ni-Cd battery	Body Size: 370*200*25mm

Model No: V-ELM2203L	Surface Treatment: SL+Green
Power: 3W	Life Span: 30000H
Charging Time: >24 Hours	Material: Alum+Glass
Working Time: >2Hours	Working Temperature: -10-45° C
Batteries: 12V AAA 600mAh	IP: 20
Ni-Cd battery	Body Size: 345*140*20mm

Sign Light Pattern



LED Emergency Light



Model No: V-KN108L Super	Color Temperature: 6500K
Power: SMD 3W	Life Span: 30000H
Input Voltage: AC220-240V 50/60Hz	Material: PC
Charging Time: 20-24 Hours	Working Temperature: -10-45° C
Working Time: 8Hours	IP: 20
Batteries: 6V 2Ah Sealed Lead-acid battery	Body Size: 360*137*87mm

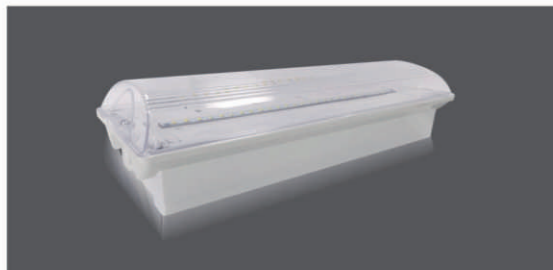

Model No: MD-KN108L	Color Temperature: 6500K
Power: SMD 4W	Life Span: 25000H
Input Voltage: AC220-240V 50/60Hz	Material: PC
Charging Time: 20-24 Hours	Working Temperature: -10-45° C
Working Time: 2Hours	IP: 20
Batteries: 3.6V 600mAh Ni-Cd battery	Body Size: 360*137*87mm



Model No: MODI-KN-118L	Color Temperature: 6500K
Power: 15W	Life Span: 25000H
Input Voltage: AC220-240V 50/60Hz	Material: PC
Charging Time: 20-24 Hours	Working Temperature: -10-45° C
Working Time: 3Hours	IP: 20
Batteries: 2*4V 900mAh Lead-acid batteries	Body Size: 325*77*51mm



LED Sensor Light & Intelligent Switch

Perfect fit for automatic illumination, hotel, stair passageway, corridor, fire exit, balcony, garage, entrance garden and other place requiring automatic illumination.



Model No: V-SDX11509S-HG	Color Temperature: 6500K
Power: 9W	Detecting angle: 120°
Detecting volume: 50dB	Material: Alum+PC
Detecting distance: ≤6M	Working Temperature: -10~45° C
Delayed time: 20~45s	IP: 20
Light sensitivity: ≤2LUX	Body Size: 230*230mm

Model No: V-SDX11515S-HG	Color Temperature: 6500K
Power: 15W	Detecting angle: 120°
Detecting volume: 50dB	Material: Alum+PC
Detecting distance: ≤6M	Working Temperature: -10~45° C
Delayed time: 20~45s	IP: 20
Light sensitivity: ≤2LUX	Body Size: 290*290mm



Model No: V-SDX12112R-HG	Color Temperature: 6500K
Power: 12W	Detecting angle: 120°
Detecting volume: 50dB	Material: Alum+PC
Detecting distance: ≤6M	Working Temperature: -10~45° C
Delayed time: 20~45s	IP: 20
Light sensitivity: ≤2LUX	Body Size: ∅235mm



Model No: V-NLQ0101-HG/WH	Color Temperature: 6500/4000/3000K
Power: 1W	Detecting angle: 120°
Detecting volume: 50dB	Work mode: Day and Night
Detecting distance: ≤6M	Working Temperature: -10~45° C
Delayed time: 20~45s	IP: 20
Light sensitivity: ≤2LUX	Body Size: 86*86mm



Model No: V-NLM0203-HG	Color Temperature: 6500/4000/3000K
Power: 3W	Detecting angle: 120°
Detecting volume: 50dB	Work mode: Day and Night
Detecting distance: ≤6M	Working Temperature: -10~45° C
Delayed time: 20~45s	IP: 20
Light sensitivity: ≤2LUX	Body Size: 73*71mm



Model No: V-B2605-LG	Color Temperature: 6500/4000/3000K
Power: 5W	Detecting angle: 360°
Detecting volume: 50dB	Work mode: Day and Night
Detecting distance: ≤6M	Working Temperature: -10~45° C
Delayed time: 20~45s	IP: 20
Light sensitivity: ≤4LUX	Body Size: ∅64*89mm



Model No: V-HGK12S-1A	Light sensitivity: ≤2LUX
Voltage: AC220~240V 50/60Hz	Detecting angle: ≤120°
Type of load: ≤200W	Work mode: Day and Night
Detecting volume: 50dB	Working Temperature: -10~45° C
Detecting distance: ≤6M	IP: 20
Delayed time: 20~45s	Body Size: 86*86mm



Model No: V-HGK11R-1A	Light sensitivity: ≤2LUX
Voltage: AC220~240V 50/60Hz	Detecting angle: ≤120°
Type of load: ≤200W	Work mode: Day and Night
Detecting volume: 50dB	Working Temperature: -10~45° C
Detecting distance: ≤6M	IP: 20
Delayed time: 20~45s	Body Size: ∅95mm



Model No: V-HGK13R-2.3A	Light sensitivity: ≤2LUX
Voltage: AC220~240V 50/60Hz	Detecting angle: ≤120°
Type of load: ≤200W	Work mode: Day and Night
Detecting volume: 50dB	Working Temperature: -10~45° C
Detecting distance: ≤6M	IP: 20
Delayed time: 20~45s	Body Size: ∅98mm



Model No: MD-MKL0102L	Surface Treatment: GY
Power: 2W	Life Span: 25000H
Input Voltage: AC220-240V 50/60Hz	Material: PC
CRI: ≥ 70	Working Temperature: $-10-45^{\circ}$ C
Beam Angle: 120°	IP: 20
Color Temperature: Purple	Body Size: 315*40*272mm



Model No: MD-MKL0104L	Surface Treatment: GY
Power: 4W	Life Span: 25000H
Input Voltage: AC220-240V 50/60Hz	Material: PC
CRI: ≥ 70	Working Temperature: $-10-45^{\circ}$ C
Beam Angle: 120°	IP: 20
Color Temperature: Purple	Body Size: 395*40*272mm



Model No: MD-MKL0106L	Surface Treatment: GY
Power: 6W	Life Span: 25000H
Input Voltage: AC220-240V 50/60Hz	Material: PC
CRI: ≥ 70	Working Temperature: $-10-45^{\circ}$ C
Beam Angle: 120°	IP: 20
Color Temperature: Purple	Body Size: 498*40*272mm

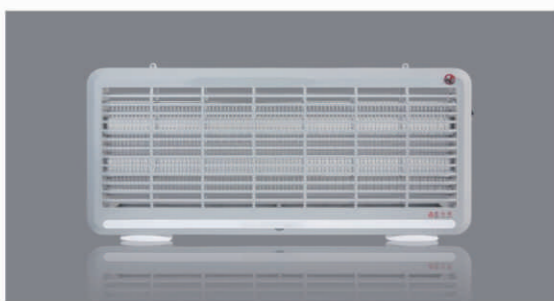

Model No: MD-MKL0108L	Surface Treatment: GY
Power: 8W	Life Span: 25000H
Input Voltage: AC220-240V 50/60Hz	Material: PC
CRI: ≥ 70	Working Temperature: $-10-45^{\circ}$ C
Beam Angle: 120°	IP: 20
Color Temperature: Purple	Body Size: 595*40*272mm



LED Track Light

Use the light and shadow features to present colorful decorative effect. Can be widely used in commercial hotel, entertainment space, home decoration, outdoor lighting, architecture landscape and other decorative environment.



Model No: V-TL3150	Surface Treatment: WH/BK
Power: COB 50W	Life Span: 30000H
Input Voltage: AC220-240V 50/60Hz	Material: Alum+PC
Luminous Flux: 4800Lm	Working Temperature: -10~45° C
CRi: ≥80	IP: 20
Beam Angle: 24°	Body Size: Φ108*180*157mm
Color Temperature: 6500/4000/3000K	Hole Size: /



V-TL3150

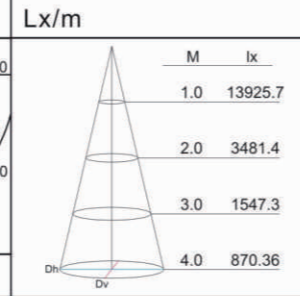
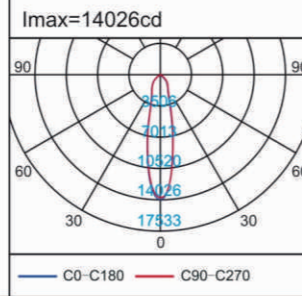
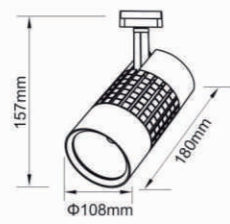

Model No: MD-TL4530	Surface Treatment: WH/BK
Power: COB 30W	Life Span: 30000H
Input Voltage: AC220-240V 50/60Hz	Material: Alum+PC
Luminous Flux: 2800Lm	Working Temperature: -10~45° C
CRi: ≥85	IP: 20
Beam Angle: 24°	Body Size: Φ98*120*160mm
Color Temperature: 6500/4000/3000K	Hole Size: /



MD-TL4530

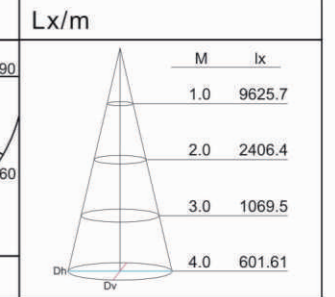
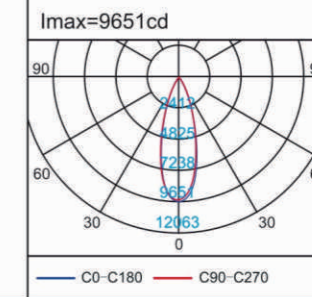
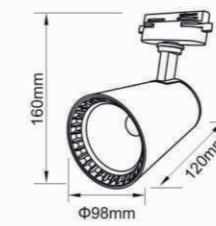

Model No: MD-TL3850	Surface Treatment: WH/BK
Power: COB 50W	Life Span: 25000H
Input Voltage: AC220-240V 50/60Hz	Material: Alum+Glass+PC
Luminous Flux: 5000Lm	Working Temperature: -10~45° C
CRi: ≥80	IP: 20
Beam Angle: 28°	Body Size: Φ105*147*235mm
Color Temperature: 6500/4000/3000K	Hole Size: /



MD-TL3850

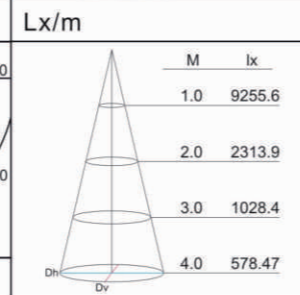
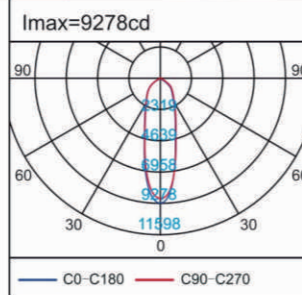
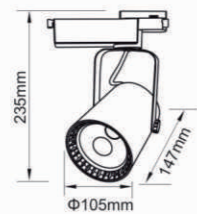

Model No: MD-TL4930	Surface Treatment: WH/BK
Power: COB 30W	Life Span: 30000H
Input Voltage: AC220-240V 50/60Hz	Material: Alum+PC
Luminous Flux: 2700Lm	Working Temperature: -10~45° C
CRi: ≥80	IP: 20
Beam Angle: 18°	Body Size: Φ90*140*170mm
Color Temperature: 6500/4000/3000K	Hole Size: /



MD-TL4930

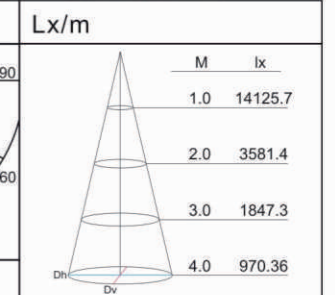
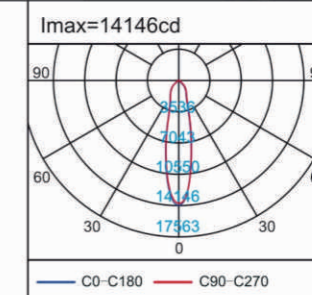
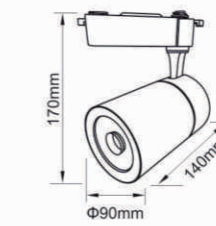

Products list

Model No.	Power	Luminous Flux	Beam angle	Surface	Body Size
MD-TL2430-A	COB 30W	2900Lm	28°	WH/BK	Φ90x145x195mm
MD-TL3850	COB 50W	5000Lm	28°	WH/BK	Φ105x147x235mm



Model No: MD-P6203R-A/B	Surface Treatment: SL
Power: 3W	Life Span: 25000H
Input Voltage: AC220-240V 50/60Hz	Material: Alum
Luminous Flux: 210Lm	Working Temperature: -10~45° C
CRt: ≥80	IP: 20
Beam Angle: 18°	Body Size: Φ50x160/260mm
Color Temperature: 6500/4000/3000K	Hole Size: /

Products list

Item NO.	Power	Luminous Flux	Beam angle	Surface	Specification
MD-P6203R-A	3W	210Lm	18°	SL	Φ50x160mm
MD-P6203R-B	3W	210Lm	18°	SL	Φ50x260mm
MD-P6303R	3W	210Lm	18°	SL	Φ40xΦ65mm



Model No: MD-P5520S-A/B	Surface Treatment: WH
Power: SMD 20W	Life Span: 25000H
Input Voltage: AC220-240V 50/60Hz	Material: Alum+PC
Luminous Flux: 1800Lm	Working Temperature: -10~50° C
CRt: ≥80	IP: 20
Beam Angle: 110°	Body Size: 415*148*59mm
Color Temperature: 6500/4000/3000K	Hole Size: /



LED
High bay

Perfect fit for Industrial Usage, Warehouse & Super Markets, Workshops, Factories, Warehouses, Highway, toll Stations, Gas Stations, Malls, Exhibition Halls, Stadiums & other vast areas.



Model No: V-MLD09100R	Surface Treatment: BK
Power: SMD 100W	Life Span: 30000H
Input Voltage: AC220-240V 50/60Hz	Material: Alum+Iron+PC
Luminous Flux: 10000Lm	Working Temperature: -10-45° C
CRI: ≥75	IP: 20
Beam Angle: 90°	Body Size: Φ165*245mm
Color Temperature: 6500/4000/3000K	Hole Size: /



V-MLD09100R

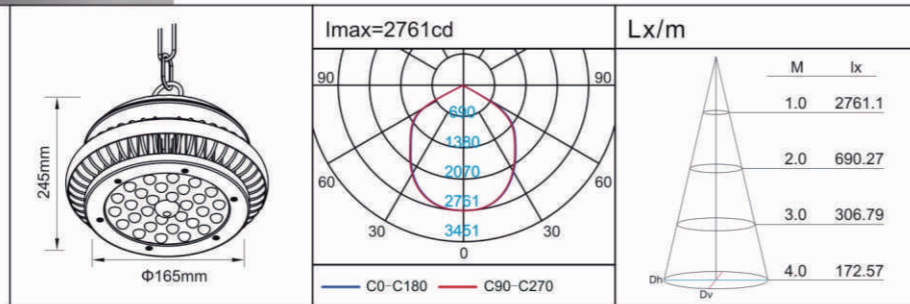

Products list

Model No.	Power	Luminous Flux	Beam angle	Surface	Body Size
V-MLD09100R	SMD 100W	10000Lm	90°	BK	Φ165*245mm
V-MLD09200R	SMD 200W	19000Lm	90°	BK	Φ175*350mm



Model No: V-MLD04100-A	Surface Treatment: SL
Power: COB 100W	Life Span: 30000H
Input Voltage: AC100-240V 50/60Hz	Material: Alum+Iron
Luminous Flux: 8500Lm	Working Temperature: -10-45° C
CRI: ≥80	IP: 20
Beam Angle: 120°	Body Size: Φ450*340mm
Color Temperature: 6500/4000/3000K	Hole Size: /



V-MLD04100-A

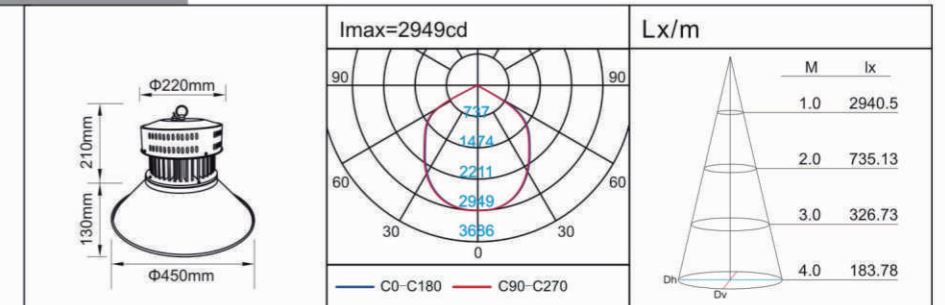

Products list

Model No.	Power	Luminous Flux	Beam angle	Surface	Body Size
V-MLD04100-A	COB 100W	8500Lm	120°	SL	Φ450x340mm
V-MLD04150	COB 3x50W	13500Lm	120°	SL	Φ495x348mm
V-MLD04200	COB 4x50W	18000Lm	120°	SL	Φ495x348mm

Model No: MD-MLD12150R	Surface Treatment: SL/BK
Power: SMD 150W	Life Span: 25000H
Input Voltage: AC220-240V 50/60Hz	Material: Alum+Iron+PC
Luminous Flux: 10000Lm	Working Temperature: -10-45° C
CRI: ≥70	IP: 20
Beam Angle: 120°	Body Size: Φ450*300mm
Color Temperature: 6500/4000/3000K	Hole Size: /



MD-MLD12150R

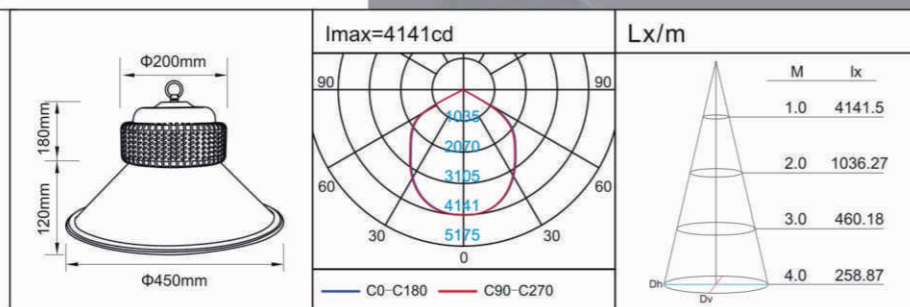

Products list

Model No.	Power	Luminous Flux	Beam angle	Surface	Body Size
MD-MLD12150R	SMD 150W	10000Lm	120°	SL/BK	Φ450x300mm
MD-MLD12200R	SMD 200W	13800Lm	120°	SL/BK	Φ495x330mm

Model No: MD-MLD04150-A	Surface Treatment: SL
Power: COB 3*50W	Life Span: 25000H
Input Voltage: AC100-240V 50/60Hz	Material: Alum+Iron
Luminous Flux: 9500Lm	Working Temperature: -10-45° C
CRI: ≥80	IP: 20
Beam Angle: 120°	Body Size: Φ495*348mm
Color Temperature: 6500/4000/3000K	Hole Size: /



MD-MLD04150

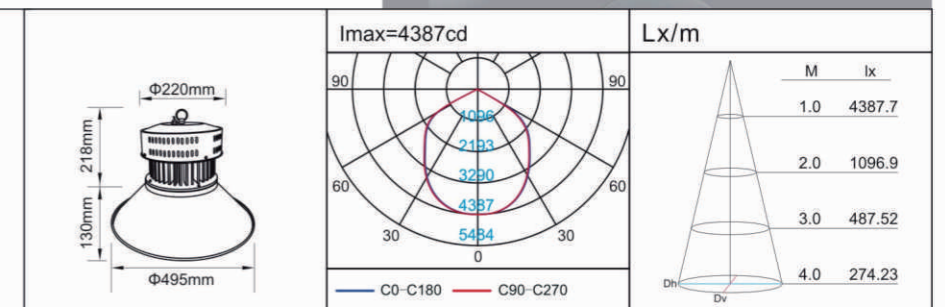

Products list

Model No.	Power	Luminous Flux	Beam angle	Surface	Body Size
MD-MLD04150-A	COB 3x50W	9500Lm	120°	SL	Φ495x348mm
MD-MLD04200-A	COB 4x50W	12000Lm	120°	SL	Φ495x348mm
MD-MLD04300-A	COB 6x50W	17000Lm	120°	SL	Φ580x540mm



Model No: V-MLD16100R	Surface Treatment: BK
Power: SMD 100W	Life Span: 30000H
Input Voltage: AC100-240V 50/60Hz	Material: Alum+PC
Luminous Flux: 9000Lm	Working Temperature: -10-45° C
CRt: ≥85	IP: 65
Beam Angle: 90°	Body Size: Φ270*170mm
Color Temperature: 6500/4000/3000K	Hole Size: /

Model No: V-MLD16200R	Surface Treatment: BK
Power: SMD 200W	Life Span: 30000H
Input Voltage: AC100-240V 50/60Hz	Material: Alum+PC
Luminous Flux: 18000Lm	Working Temperature: -10-45° C
CRt: ≥85	IP: 65
Beam Angle: 90°	Body Size: Φ380*170mm
Color Temperature: 6500/4000/3000K	Hole Size: /

Model No: MD-MLD15100R	Surface Treatment: BK
Power: SMD 100W	Life Span: 25000H
Input Voltage: AC220-240V 50/60Hz	Material: Alum+PC
Luminous Flux: 8000Lm	Working Temperature: -10-45° C
CRt: ≥80	IP: 65
Beam Angle: 90°	Body Size: Φ300*160mm
Color Temperature: 6500/4000/3000K	Hole Size: /



MD-MLD15100R

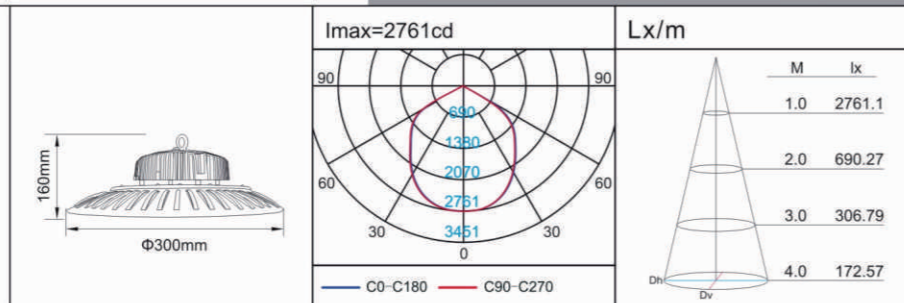

Products list

Model No.	Power	Luminous Flux	Beam angle	Surface	Body Size
MD-MLD15100R	SMD 100W	8000Lm	90°	BK	Φ300x160mm
MD-MLD15200R	SMD 200W	13000Lm	90°	BK	Φ400x170mm



Model No: MD-MLD03100	Surface Treatment: SL
Power: SMD 100W	Life Span: 25000H
Input Voltage: AC220-240V 50/60Hz	Material: Alum+PC
Luminous Flux: 6200Lm	Working Temperature: -10-45° C
CRt: ≥70	IP: 20
Beam Angle: 100°	Body Size: Φ430*200mm
Color Temperature: 6500/4000/3000K	Hole Size: /



LED
Solar Light

Can be widely used in gardens, outdoor residential areas, walkways & passages, driveways, fountains, lawns, entrance, patio or terrace and similar environments. Solar Light no connection required for safety and environmental protection.

Color Temperature:	6500K
Surface Treatment:	BK
Material:	Alum+PC
Working Temperature:	-10~50° C
IP:	65
Body Size:	240*200*55mm
Solar Panel size:	345*295*17mm



Model	Solar Panel	Luminous Flux	Beam angle	Body Size	Solar panel size
MODI 800Lm	6V 15W	800Lm	100°	240x200x55mm	345x295x17mm
MODI 1800Lm	10V 18W	1800Lm	100°	285x255x55mm	355x355x17mm
MODI 2300Lm	10V 22W	2300Lm	100°	340x315x60mm	365x300x25mm



Model No:	MD-SLT0810L	Sensing distances:	5~8m
Power:	10W	Surface Treatment:	GY
Input Voltage:	AC220-240V 50/60Hz	Life Span:	25000H
Batteries:	7.5Ah Li-ion Battery	Material:	Alum+Glass
Charging Time:	6~8hours	Working Temperature:	-10~50° C
Working Time:	>8 hours	IP:	65
Working mode:	Remote+ Light+Time-control	Body Size:	285*180*47mm



Model No:	MD-SLT1240L	Sensing distances:	5~8m
Luminous Flux:	3000Lm	Surface Treatment:	BK
Input Voltage:	AC220-240V 50/60Hz	Life Span:	25000H
Batteries:	6*(3.7V 2Ah Li-ion battery)	Material:	Alum+PC
Charging Time:	8~12 hours	Working Temperature:	-10~50° C
Working Time:	12 hours	IP:	65
Working mode:	Remote+ Light+Time-control	Body Size:	493*220*98mm



MODI 10RT-100-IP65			
Power:	3W	Solar panel:	2V 70mA
Specification:	100LEDs	Life Span:	25000H
Battery:	1*AA 12V 400mAh Ni-Cd	Material:	Cu+PC
Charging Time:	>8 hours	Working Temperature:	-10~45° C
Color Temperature:	WH/NW/WW/RED/ GREEN/BLUE/RGB.	IP:	65
		Manner Of Packing:	10m/Pcs



Model No:	V-WLT19501L	Surface Treatment:	BK
Power:	SMD 1W	Motion Angle:	≥120°
Batteries:	3.7V 1Ah Li-ion Battery	Distance:	≤5m
Charging Time:	8 Hours	Material:	ABC Plastic
Working Time:	6~8 Hours(Full Change)	Working Temperature:	-10~50° C
Working mode:	Light+ Motion Sensor	IP:	65
Delay Time:	15s	Body Size:	87*110*21mm

Model No:	V-WLT19502L	Surface Treatment:	BK
Power:	SMD 2W	Motion Angle:	≥120°
Batteries:	3.7V 2Ah Li-ion Battery	Distance:	≤5m
Charging Time:	8 Hours	Material:	ABC Plastic
Working Time:	6~8 Hours(Full Change)	Working Temperature:	-10~50° C
Working mode:	Light+ Motion Sensor	IP:	65
Delay Time:	15s	Body Size:	168*111*24mm



Model No:	MD-WLT13302L/A	Surface Treatment:	BK
Power:	SMD/COB 2W	Motion Angle:	≥120°
Batteries:	3.7V 12Ah Li-ion Battery	Distance:	≤3m
Charging Time:	8 Hours	Material:	ABC Plastic
Working Time:	6~8 Hours(Full Change)	Working Temperature:	-10~50° C
Working mode:	Light+ Motion Sensor	IP:	65
Delay Time:	30s	Body Size:	124*96*48mm

Model No:	MD-WLT13302L-2	Surface Treatment:	BK
Power:	SMD 5W	Motion Angle:	≥120°
Batteries:	7.4V 2.4Ah Li-ion Battery	Distance:	≤3m
Charging Time:	8 Hours	Material:	ABC Plastic
Working Time:	6~8 Hours(Full Change)	Working Temperature:	-10~50° C
Working mode:	Light+ Motion Sensor	IP:	65
Delay Time:	30s	Body Size:	192*115*45mm



Model No:	V-WLT9702R	Color Temperature:	6500/4000/3000K
Power:	SMD 2W	Surface Treatment:	BK
Batteries:	2*1.1Ah LiFePO4 3.2V	Life Span:	30000H
Charging Time:	>10 hours	Material:	Alum+PC+Glass
Working Time:	6~8 Hours(Full Change)	Working Temperature:	-10~50° C
Luminous Flux:	≥120Lm	IP:	65
CRI:	≥70	Body Size:	255*200*362mm

Model No:	V-CT1602R-A	Color Temperature:	6500/4000/3000K
Power:	SMD 2W	Surface Treatment:	BK
Batteries:	2*1.1Ah LiFePO4 3.2V	Life Span:	30000H
Charging Time:	>10 hours	Material:	Alum+PC+Glass
Working Time:	6~8 Hours(Full Change)	Working Temperature:	-10~50° C
Luminous Flux:	≥120Lm	IP:	65
CRI:	≥70	Body Size:	160*200*430mm

Model No:	V-CT1602R-B	Color Temperature:	6500/4000/3000K
Power:	SMD 2W	Surface Treatment:	BK
Batteries:	2*1.1Ah LiFePO4 3.2V	Life Span:	30000H
Charging Time:	>10 hours	Material:	Alum+PC+Glass
Working Time:	6~8 Hours(Full Change)	Working Temperature:	-10~50° C
Luminous Flux:	≥120Lm	IP:	65
CRI:	≥70	Body Size:	200*200*1050mm

Model No:	V-CT1602R-B	Color Temperature:	6500/4000/3000K
Power:	SMD 2W	Surface Treatment:	BK
Batteries:	2*1.1Ah LiFePO4 3.2V	Life Span:	30000H
Charging Time:	>10 hours	Material:	Alum+PC+Glass
Working Time:	6~8 Hours(Full Change)	Working Temperature:	-10~50° C
Luminous Flux:	≥120Lm	IP:	65
CRI:	≥70	Body Size:	204*204*1900mm



Solar Light

Model No: V-ILT0801R	Color Temperature: 6500/4000/3000K
Power: SMD 1W	Surface Treatment: BK
Batteries: 1500mAh Ni-Mh 3.6V	Life Span: 30000H
Charging Time: >10 hours	Material: Alum+PC
Working Time: 6-8 Hours(Full Change)	Working Temperature: -10-50° C
Luminous Flux: ≥20Lm	IP: 65
CRt: ≥70	Body Size: φ162*190mm

Model No: MD-IL0702R	Color Temperature: 6500/4000/3000K
Power: SMD 2W	Surface Treatment: BK
Batteries: 1500mAh Ni-Mh 7.2V	Life Span: 25000H
Charging Time: >10 hours	Material: Alum+PC
Working Time: 6-8 Hours(Full Change)	Working Temperature: -10-50° C
Luminous Flux: ≥40Lm	IP: 65
CRt: ≥70	Body Size: 182*120*302mm



Solar Light

Model No: MD-ILT13R	Color Temperature: 6500/4000/3000K
Solar Panel: 0.3W	Surface Treatment: BK
Batteries: 800mAh Ni-Mh 12V	Life Span: 25000H
Charging Time: >10 hours	Material: Alum+PC
Working Time: ≥6 Hours(Full Change)	Working Temperature: -10-50° C
Luminous Flux: /	IP: 65
CRt: ≥70	Body Size: φ130*405mm

Model No: MD-ILT14R	Color Temperature: 6500/4000/3000K
Solar Panel: 0.3W	Surface Treatment: BK
Batteries: 800mAh Ni-Mh 12V	Life Span: 25000H
Charging Time: >10 hours	Material: Alum+PC
Working Time: ≥6 Hours(Full Change)	Working Temperature: -10-50° C
Luminous Flux: /	IP: 65
CRt: ≥70	Body Size: φ140*505mm

Model No: MD-ILT15S	Color Temperature: 6500/4000/3000K
Solar Panel: 0.25W	Surface Treatment: BK
Batteries: AA 600mAh Ni-Mh 12V	Life Span: 25000H
Charging Time: >10 hours	Material: Alum+PC
Working Time: ≥6 Hours(Full Change)	Working Temperature: -10-50° C
Luminous Flux: /	IP: 65
CRt: ≥70	Body Size: 110*110*355mm

LED Home decor light

Widely used in hotels, bars, leisure places, home lighting and other lighting environment.

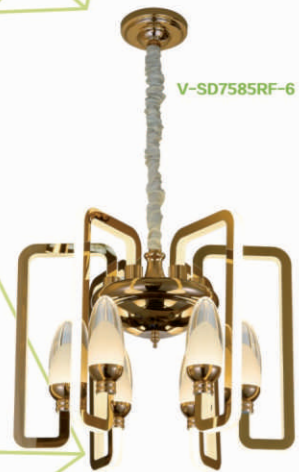

V-SD7585RF-6

Power: SMD 85W	Surface Treatment: CH/HG
Input Voltage: AC220-240V 50/60Hz	Life Span: 30000H
Luminous Flux: >60Lm/W	Material: Iron+Acrylic
CRt: ≥80	Working Temperature: -10-45° C
Beam Angle: 360°	IP: 20
Color Temperature: 4000K	Body Size: Φ480*370mm



V-SD75168RF-10

Power: SMD 168W	Surface Treatment: CH/HG
Input Voltage: AC220-240V 50/60Hz	Life Span: 30000H
Luminous Flux: >60Lm/W	Material: Iron+Acrylic
CRt: ≥80	Working Temperature: -10-45° C
Beam Angle: 360°	IP: 20
Color Temperature: 4000K	Body Size: Φ735*415mm



V-SD76132RF-6

Power: SMD 132W	Surface Treatment: CH/HG
Input Voltage: AC220-240V 50/60Hz	Life Span: 30000H
Luminous Flux: >60Lm/W	Material: Iron+Acrylic
CRt: ≥80	Working Temperature: -10-45° C
Beam Angle: 360°	IP: 20
Color Temperature: 4000K	Body Size: Φ650*410mm



V-SD76324RF-12

Power: SMD 324W	Surface Treatment: CH/HG
Input Voltage: AC220-240V 50/60Hz	Life Span: 30000H
Luminous Flux: >60Lm/W	Material: Iron+Acrylic
CRt: ≥80	Working Temperature: -10-45° C
Beam Angle: 360°	IP: 20
Color Temperature: 4000K	Body Size: Φ920*480mm



V-SD1850R
V-SD1860R

Power: SMD 50/60W	Surface Treatment: WH
Input Voltage: AC220-240V 50/60Hz	Life Span: 30000H
Luminous Flux: >60Lm/W	Material: Alum+Acrylic
CRt: ≥80	Working Temperature: -10-45° C
Beam Angle: 120°	IP: 20
Color Temperature: 4000K	Body Size: Φ(400/500)mm



V-SD1840S
V-SD1850S

Power: SMD 40/50W	Surface Treatment: WH
Input Voltage: AC220-240V 50/60Hz	Life Span: 30000H
Luminous Flux: >60Lm/W	Material: Alum+Acrylic
CRt: ≥80	Working Temperature: -10-45° C
Beam Angle: 120°	IP: 20
Color Temperature: 4000K	Body Size: □(340/420)mm



V-SD18120R

Power: 120W	Surface Treatment: WH
Input Voltage: AC220-240V 50/60Hz	Life Span: 30000H
Luminous Flux: >60Lm/W	Material: Alum+Acrylic
CRt: ≥80	Working Temperature: -10-45° C
Beam Angle: 120°	IP: 20
Color Temperature: 4000K	Body Size: Φ(400+600)mm



V-SD18102S

Power: SMD 102W	Surface Treatment: WH
Input Voltage: AC220-240V 50/60Hz	Life Span: 30000H
Luminous Flux: >60Lm/W	Material: Alum+Acrylic
CRt: ≥80	Working Temperature: -10-45° C
Beam Angle: 120°	IP: 20
Color Temperature: 4000K	Body Size: □(340+510)mm



V-SD18220R

Power: SMD 220W	Surface Treatment: WH
Input Voltage: AC220-240V 50/60Hz	Life Span: 30000H
Luminous Flux: >60Lm/W	Material: Alum+Acrylic
CRt: ≥80	Working Temperature: -10-45° C
Beam Angle: 120°	IP: 20
Color Temperature: 4000K	Body Size: Φ(400+600+800)mm



V-SD18180S

Power: SMD 180W	Surface Treatment: WH
Input Voltage: AC220-240V 50/60Hz	Life Span: 30000H
Luminous Flux: >60Lm/W	Material: Alum+Acrylic
CRt: ≥80	Working Temperature: -10-45° C
Beam Angle: 120°	IP: 20
Color Temperature: 4000K	Body Size: □(340+510+680)mm



V-SD2802-27

Power: SMD 27*2W	Surface Treatment: CH/HG
Input Voltage: AC220-240V 50/60Hz	Life Span: 30000H
Luminous Flux: >60Lm/W	Material: Alum+Iron+Acrylic
CRt: ≥80	Working Temperature: -10-45° C
Beam Angle: 360°	IP: 20
Color Temperature: 3000K	Body Size: φ350*1200mm

Power: SMD 36*2W	Surface Treatment: CH/HG
Input Voltage: AC220-240V 50/60Hz	Life Span: 30000H
Luminous Flux: >60Lm/W	Material: Alum+Iron+PMMA
CRt: ≥80	Working Temperature: -10-45° C
Beam Angle: 360°	IP: 20
Color Temperature: 3000K	Body Size: φ400*1200mm



V-SD2802-36

Power: SMD 54*2W	Surface Treatment: CH/HG
Input Voltage: AC220-240V 50/60Hz	Life Span: 30000H
Luminous Flux: >60Lm/W	Material: Alum+Iron+PMMA
CRt: ≥80	Working Temperature: -10-45° C
Beam Angle: 360°	IP: 20
Color Temperature: 3000K	Body Size: φ520*1200mm



V-SD3002-54

Power: SMD 54*2W	Surface Treatment: WH
Input Voltage: AC220-240V 50/60Hz	Life Span: 30000H
Luminous Flux: >60Lm/W	Material: Alum+Iron+Acrylic
CRt: ≥80	Working Temperature: -10-45° C
Beam Angle: 120°	IP: 20
Color Temperature: 3000K	Body Size: 533*784mm



V-SD2602I-54



V-SD2602I-75

Power: SMD 75*2W	Surface Treatment: WH
Input Voltage: AC220-240V 50/60Hz	Life Span: 30000H
Luminous Flux: >60Lm/W	Material: Alum+Iron+Acrylic
CRt: ≥80	Working Temperature: -10-45° C
Beam Angle: 120°	IP: 20
Color Temperature: 3000K	Body Size: 673*963mm

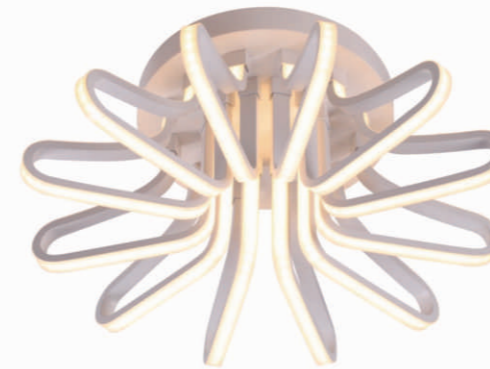

V-SDX4412R-12

Power: SMD 12*12W	Surface Treatment: WH
Input Voltage: AC220-240V 50/60Hz	Life Span: 30000H
Luminous Flux: >60Lm/W	Material: Alum+Iron+PC
CRt: ≥80	Working Temperature: -10-45° C
Beam Angle: 120°	IP: 20
Color Temperature: 4000K	Body Size: φ600*200mm

Power: SMD 8*(12+15)W	Surface Treatment: WH
Input Voltage: AC220-240V 50/60Hz	Life Span: 30000H
Luminous Flux: >60Lm/W	Material: Alum+Iron+PC
CRt: ≥80	Working Temperature: -10-45° C
Beam Angle: 120°	IP: 20
Color Temperature: 4000K	Body Size: φ600*222mm



V-SDX44216R-16



V-SDX64198S

Power: SMD 198W	Surface Treatment: WH
Input Voltage: AC220-240V 50/60Hz	Life Span: 30000H
Luminous Flux: >60Lm/W	Material: Alum+Iron+PC
CRt: ≥80	Working Temperature: -10-45° C
Beam Angle: 120°	IP: 20
Color Temperature: 4000K	Body Size: 560*450*190mm



V-SD3315S-1

Power: SMD 15W	Surface Treatment: WH/BK
Input Voltage: AC220-240V 50/60Hz	Life Span: 30000H
Luminous Flux: 1300Lm	Material: Alum+Iron
CRI: ≥80	Working Temperature: -10-45° C
Beam Angle: 120°	IP: 20
Color Temperature: 3000K	Body Size: 200*100*70mm



V-SD3315S-4

Power: SMD 4*15W	Surface Treatment: WH/BK/WH+BK
Input Voltage: AC220-240V 50/60Hz	Life Span: 30000H
Luminous Flux: 4500Lm	Material: Alum+Iron
CRI: ≥80	Working Temperature: -10-45° C
Beam Angle: 120°	IP: 20
Color Temperature: 3000K	Body Size: 330*330*150mm



V-SD3315S-6

Power: SMD 6*15W	Surface Treatment: WH/BK/WH+BK
Input Voltage: AC220-240V 50/60Hz	Life Span: 30000H
Luminous Flux: 6600Lm	Material: Alum+Iron
CRI: ≥80	Working Temperature: -10-45° C
Beam Angle: 120°	IP: 20
Color Temperature: 3000K	Body Size: 300*560*150mm



V-SD3315S-9

Power: SMD 9*15W	Surface Treatment: WH/BK/WH+BK
Input Voltage: AC220-240V 50/60Hz	Life Span: 30000H
Luminous Flux: 7900Lm	Material: Alum+Iron
CRI: ≥80	Working Temperature: -10-45° C
Beam Angle: 120°	IP: 20
Color Temperature: 3000K	Body Size: 580*580*150mm



V-SD3315S-16

Power: SMD 16*15W	Surface Treatment: WH/BK/WH+BK
Input Voltage: AC220-240V 50/60Hz	Life Span: 30000H
Luminous Flux: 15000Lm	Material: Alum+Iron
CRI: ≥80	Working Temperature: -10-45° C
Beam Angle: 120°	IP: 20
Color Temperature: 3000K	Body Size: 800*800*150mm



V-SD3315S-18

Power: SMD 18*15W	Surface Treatment: WH/BK/WH+BK
Input Voltage: AC220-240V 50/60Hz	Life Span: 30000H
Luminous Flux: 17600Lm	Material: Alum+Iron
CRI: ≥80	Working Temperature: -10-45° C
Beam Angle: 120°	IP: 20
Color Temperature: 3000K	Body Size: 1100*690*150mm



V-SDX13480SF

Power: SMD 80W	Surface Treatment: WH+BK
Input Voltage: AC220-240V 50/60Hz	Life Span: 30000H
Luminous Flux: >90Lm/W	Material: Iron+Plastic
CRI: ≥80	Working Temperature: -10-45° C
Beam Angle: 120°	IP: 20
Color Temperature: 3 color	Body Size: 550*550*110mm



V-SDX134240SF

Power: SMD 240W	Surface Treatment: WH+BK
Input Voltage: AC220-240V 50/60Hz	Life Span: 30000H
Luminous Flux: >90Lm/W	Material: Iron+Plastic
CRI: ≥80	Working Temperature: -10-45° C
Beam Angle: 120°	IP: 20
Color Temperature: 3 color	Body Size: 1125*760*110mm

Power: SMD 4*20W	Surface Treatment: WH+GL
Input Voltage: AC220-240V 50/60Hz	Life Span: 30000H
Luminous Flux: >90Lm/W	Material: Iron+Plastic
CRI: ≥80	Working Temperature: -10-45° C
Beam Angle: 120°	IP: 20
Color Temperature: 3 color	Body Size: 520*520*100mm



V-SDX13520SF-4



V-SDX13530SF-6

Power: SMD 6*30W	Surface Treatment: WH+GL
Input Voltage: AC220-240V 50/60Hz	Life Span: 30000H
Luminous Flux: >90Lm/W	Material: Iron+Plastic
CRI: ≥80	Working Temperature: -10-45° C
Beam Angle: 120°	IP: 20
Color Temperature: 3 color	Body Size: 960*680*100mm

V-SDX13372RF



Power: SMD 72W	Surface Treatment: Golden
Input Voltage: AC220-240V 50/60Hz	Life Span: 30000H
Luminous Flux: 4600Lm/W	Material: Iron+Plastic
CRt: ≥80	Working Temperature: -10~45° C
Beam Angle: 120°	IP: 20
Color Temperature: 3 color	Body Size: Φ500mm

Power: SMD 36/50W	Surface Treatment: White/Blue/Pink
Input Voltage: AC220-240V 50/60Hz	Life Span: 30000H
Luminous Flux: >60Lm/W	Material: Iron+Acrylic+Plastic
CRt: ≥80	Working Temperature: -10~45° C
Beam Angle: 120°	IP: 20
Color Temperature: 3 color	Body Size: Φ400/500mm



V-SDX5236RF
V-SDX5250RF

Power: SMD 36/50W	Surface Treatment: White/Blue/Pink
Input Voltage: AC220-240V 50/60Hz	Life Span: 30000H
Luminous Flux: >60Lm/W	Material: Iron+Acrylic+Plastic
CRt: ≥80	Working Temperature: -10~45° C
Beam Angle: 120°	IP: 20
Color Temperature: 3 color	Body Size: D400/500mm



V-SDX5236SF
V-SDX5250SF

Power: SMD 36/60W	Surface Treatment: White
Input Voltage: AC220-240V 50/60Hz	Life Span: 30000H
Luminous Flux: >100Lm/W	Material: Plastic
CRt: ≥80	Working Temperature: -10~45° C
Beam Angle: 120°	IP: 20
Color Temperature: 3 color+6W Night Light	Body Size: Φ340/450*75mm



Switch + APP

V-SDX13136RF
V-SDX13160RF

Power: SMD 36W	Surface Treatment: White/Blue/Pink
Input Voltage: AC220-240V 50/60Hz	Life Span: 25000H
Luminous Flux: 3000Lm	Material: Iron+Acrylic+Plastic
CRt: ≥75	Working Temperature: -10~45° C
Beam Angle: 120°	IP: 20
Color Temperature: 3 color	Body Size: Φ400mm



MD-SDX12436RF

Power: SMD 36W	Surface Treatment: White/Blue/Pink
Input Voltage: AC220-240V 50/60Hz	Life Span: 25000H
Luminous Flux: 3000Lm	Material: Iron+Acrylic+Plastic
CRt: ≥75	Working Temperature: -10~45° C
Beam Angle: 120°	IP: 20
Color Temperature: 3 color	Body Size: Φ395mm



MD-SDX12536RF

Power: SMD 36W	Surface Treatment: White/Blue/Pink
Input Voltage: AC220-240V 50/60Hz	Life Span: 25000H
Luminous Flux: 3000Lm	Material: Iron+Plastic
CRt: ≥75	Working Temperature: -10~45° C
Beam Angle: 120°	IP: 20
Color Temperature: 3 color	Body Size: Φ395mm



MD-SDX111740RF

Power: SMD 40W	Surface Treatment: White/Blue/Pink/Orange
Input Voltage: AC220-240V 50/60Hz	Life Span: 30000H
Luminous Flux: >60Lm/W	Material: Iron+Plastic
CRt: ≥80	Working Temperature: -10~45° C
Beam Angle: 120°	IP: 20
Color Temperature: 3 color	Body Size: Φ450mm



V-SDX8896SF-4

Power: SMD 96W	Surface Treatment: WH
Input Voltage: AC220-240V 50/60Hz	Life Span: 30000H
Luminous Flux: >60lm/W	Material: Iron+Plastic
CRI: ≥80	Working Temperature: -10~45° C
Beam Angle: 120°	IP: 20
Color Temperature: 6500K+3000K	Body Size: 540*540*145mm

Power: SMD 210W	Surface Treatment: WH
Input Voltage: AC220-240V 50/60Hz	Life Span: 30000H
Luminous Flux: >60lm/W	Material: Iron+Plastic
CRI: ≥80	Working Temperature: -10~45° C
Beam Angle: 120°	IP: 20
Color Temperature: 6500K+3000K	Body Size: 810*810*145mm



V-SDX88210SF-9

Power: SMD 284W	Surface Treatment: WH
Input Voltage: AC220-240V 50/60Hz	Life Span: 30000H
Luminous Flux: >60lm/W	Material: Iron+Plastic
CRI: ≥80	Working Temperature: -10~45° C
Beam Angle: 120°	IP: 20
Color Temperature: 6500K+3000K	Body Size: 1080*810*145mm



V-SDX88284SF-12

Power: SMD 124W	Surface Treatment: WH
Input Voltage: AC220-240V 50/60Hz	Life Span: 30000H
Luminous Flux: >60lm/W	Material: Iron+Plastic
CRI: ≥80	Working Temperature: -10~45° C
Beam Angle: 120°	IP: 20
Color Temperature: 6500K+3000K	Body Size: 670*670*145mm

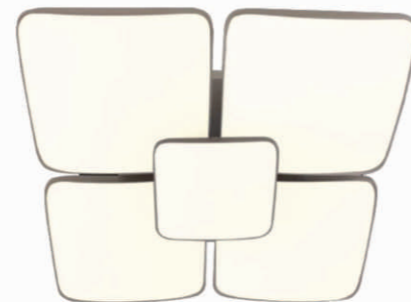

V-SDX87124SF-5

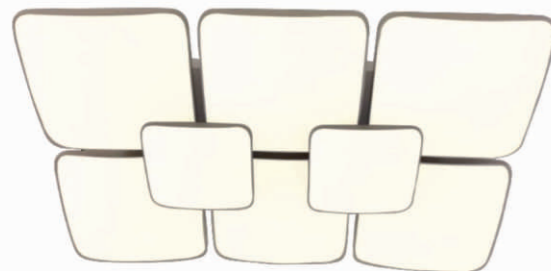

V-SDX87196SF-8

Power: SMD 196W	Surface Treatment: WH
Input Voltage: AC220-240V 50/60Hz	Life Span: 30000H
Luminous Flux: >60lm/W	Material: Iron+Plastic
CRI: ≥80	Working Temperature: -10~45° C
Beam Angle: 120°	IP: 20
Color Temperature: 6500K+3000K	Body Size: 1020*670*145mm



MD-SDX11636RF
MD-SDX11672RF

Power: SMD 36/72W	Surface Treatment: WH+SL/GD
Input Voltage: AC220-240V 50/60Hz	Life Span: 30000H
Luminous Flux: >70lm/W	Material: Iron+Plastic
CRI: ≥85	Working Temperature: -10~45° C
Beam Angle: 120°	IP: 20
Color Temperature: 3 color	Body Size: φ380/490mm

Power: SMD 35/45W	Surface Treatment: WH
Input Voltage: AC220-240V 50/60Hz	Life Span: 30000H
Luminous Flux: >60lm/W	Material: Iron+Plastic+PS
CRI: ≥80	Working Temperature: -10~45° C
Beam Angle: 120°	IP: 20
Color Temperature: 3 color	Body Size: φ375/475mm



V-SDX6335RF
V-SDX6345RF



V-SDX6345SF
V-SDX6350SF

Power: SMD 45/50W	Surface Treatment: WH
Input Voltage: AC220-240V 50/60Hz	Life Span: 30000H
Luminous Flux: >60lm/W	Material: Iron+Plastic+PS
CRI: ≥80	Working Temperature: -10~45° C
Beam Angle: 120°	IP: 20
Color Temperature: 3 color	Body Size: □400/500mm



V-LH0212LF-C
V-LH0215LF-C

Power: SMD 12/15W	Surface Treatment: SL/CH/HG
Input Voltage: AC220-240V 50/60Hz	Life Span: 30000H
Luminous Flux: >60Lm/W	Material: Iron+Acrylic
CRt: ≥80	Working Temperature: -10-45° C
Beam Angle: 120°	IP: 20
Color Temperature: 3 color	Body Size: (550/620)*110mm

Power: SMD 12/15W	Surface Treatment: SL/CH/HG
Input Voltage: AC220-240V 50/60Hz	Life Span: 30000H
Luminous Flux: >60Lm/W	Material: Iron+Acrylic
CRt: ≥80	Working Temperature: -10-45° C
Beam Angle: 120°	IP: 20
Color Temperature: 3 color	Body Size: (550/620)*80mm



V-LH0612LF
V-LH0615LF

Power: SMD 12/15W	Surface Treatment: SL/CH/HG
Input Voltage: AC220-240V 50/60Hz	Life Span: 30000H
Luminous Flux: >60Lm/W	Material: Alum+Plastic
CRt: ≥80	Working Temperature: -10-45° C
Beam Angle: 120°	IP: 20
Color Temperature: 3 color	Body Size: (530/640)*210mm



V-LH0912L
V-LH0915L

Power: SMD 12W	Surface Treatment: WH
Input Voltage: AC220-240V 50/60Hz	Life Span: 30000H
Luminous Flux: >60Lm/W	Material: Alum+Iron+PC
CRt: ≥80	Working Temperature: -10-45° C
Beam Angle: 120°	IP: 20
Color Temperature: 3 color	Body Size: 680*105mm



V-LH0812LF



Model No: V-WL4604E	Surface Treatment: WH
Power: SMD 4W	Life Span: 30000H
Input Voltage: AC220-240V 50/60Hz	Material: Alum+Iron
Luminous Flux: 210Lm	Working Temperature: -10-45° C
CRt: ≥80	IP: 20
Color Temperature: 6500/4000/3000K	Body Size: 160*90*100mm



Model No: V-WL4509E	Surface Treatment: WH
Power: SMD 9W	Life Span: 30000H
Input Voltage: AC220-240V 50/60Hz	Material: Alum+Iron
Luminous Flux: 480Lm	Working Temperature: -10-45° C
CRt: ≥80	IP: 20
Color Temperature: 6500/4000/3000K	Body Size: 300*175*245mm

Model No: V-WL4705L	Surface Treatment: WH
Power: SMD 5W	Life Span: 30000H
Input Voltage: AC220-240V 50/60Hz	Material: Alum+Iron+Acrylic
Luminous Flux: 210Lm	Working Temperature: -10-45° C
CRt: ≥80	IP: 20
Color Temperature: 6500/4000/3000K	Body Size: 160*120*40mm



Model No: V-WL4709L	Surface Treatment: WH
Power: SMD 9W	Life Span: 30000H
Input Voltage: AC220-240V 50/60Hz	Material: Alum+Iron+Acrylic
Luminous Flux: 420Lm	Working Temperature: -10-45° C
CRt: ≥80	IP: 20
Color Temperature: 6500/4000/3000K	Body Size: 260*120*40mm



Model No: V-WL12708L	Surface Treatment: WH
Power: SMD 8W	Life Span: 30000H
Input Voltage: AC220-240V 50/60Hz	Material: Iron+Acrylic
Luminous Flux: ≥60Lm	Working Temperature: -10-45° C
CRt: ≥80	IP: 20
Color Temperature: 6500/4000/3000K	Body Size: 120*310*45mm



Model No: V-WL12716L	Surface Treatment: WH
Power: SMD 16W	Life Span: 30000H
Input Voltage: AC220-240V 50/60Hz	Material: Iron+Acrylic
Luminous Flux: ≥120Lm	Working Temperature: -10-45° C
CRt: ≥80	IP: 20
Color Temperature: 6500/4000/3000K	Body Size: 220*100*45mm

Model No: V-WL12708L-A	Surface Treatment: WH
Power: SMD 8W	Life Span: 30000H
Input Voltage: AC220-240V 50/60Hz	Material: Iron+Acrylic
Luminous Flux: ≥60Lm	Working Temperature: -10-45° C
CRt: ≥80	IP: 20
Color Temperature: 6500/4000/3000K	Body Size: 120*100*45mm





Model No: V-WL13202-3	Surface Treatment: WH
Power: SMD 3*2W	Life Span: 30000H
Input Voltage: AC220-240V 50/60Hz	Material: Alum+Iron+Acrylic
Luminous Flux: ≥60Lm	Working Temperature: -10~45° C
CRt: ≥80	IP: 20
Color Temperature: 6500/4000/3000K	Body Size: 332*125*160mm



Model No: V-WL13202-6	Surface Treatment: WH
Power: SMD 6*2W	Life Span: 30000H
Input Voltage: AC220-240V 50/60Hz	Material: Alum+Iron+Acrylic
Luminous Flux: ≥60Lm	Working Temperature: -10~45° C
CRt: ≥80	IP: 20
Color Temperature: 6500/4000/3000K	Body Size: 425*125*160mm

Model No: V-WL13202-9	Surface Treatment: WH
Power: SMD 9*2W	Life Span: 30000H
Input Voltage: AC220-240V 50/60Hz	Material: Alum+Iron+Acrylic
Luminous Flux: ≥60Lm	Working Temperature: -10~45° C
CRt: ≥80	IP: 20
Color Temperature: 6500/4000/3000K	Body Size: 600*125*160mm



Model No: V-WL10904E-2	Surface Treatment: WH
Power: SMD 2*4W	Life Span: 30000H
Input Voltage: AC220-240V 50/60Hz	Material: Alum+Iron+Acrylic
Luminous Flux: ≥60Lm	Working Temperature: -10~45° C
CRt: ≥80	IP: 20
Color Temperature: 6500/4000/3000K	Body Size: 120*90*60mm

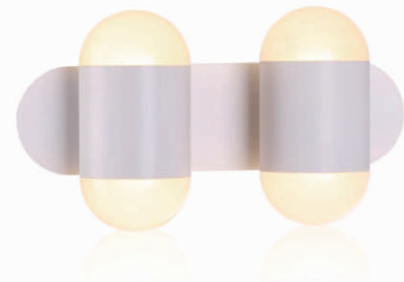

Model No: V-WL10904E-4	Surface Treatment: WH
Power: SMD 4*4W	Life Span: 30000H
Input Voltage: AC220-240V 50/60Hz	Material: Alum+Iron+Acrylic
Luminous Flux: ≥60Lm	Working Temperature: -10~45° C
CRt: ≥80	IP: 20
Color Temperature: 6500/4000/3000K	Body Size: 220*120*90mm

Model No: V-WL10904E-6	Surface Treatment: WH
Power: SMD 6*4W	Life Span: 30000H
Input Voltage: AC220-240V 50/60Hz	Material: Alum+Iron+Acrylic
Luminous Flux: ≥60Lm	Working Temperature: -10~45° C
CRt: ≥80	IP: 20
Color Temperature: 6500/4000/3000K	Body Size: 300*120*90mm



Model No: V-WL11007L-2	Surface Treatment: WH
Power: SMD 2*7W	Life Span: 30000H
Input Voltage: AC220-240V 50/60Hz	Material: Alum+Iron+Acrylic
Luminous Flux: 900Lm	Working Temperature: -10~45° C
CRt: ≥80	IP: 20
Color Temperature: 6500/4000/3000K	Body Size: 220*120*43mm

Model No: V-WL11007E-2	Surface Treatment: WH
Power: SMD 2*7W	Life Span: 30000H
Input Voltage: AC220-240V 50/60Hz	Material: Alum+Iron+Acrylic
Luminous Flux: 850Lm	Working Temperature: -10~45° C
CRt: ≥80	IP: 20
Color Temperature: 6500/4000/3000K	Body Size: φ200*45mmmm



Model No: V-WL12808R	Surface Treatment: BK
Power: SMD 8W	Life Span: 30000H
Input Voltage: AC220-240V 50/60Hz	Material: Iron+Acrylic
Luminous Flux: ≥60Lm	Working Temperature: -10~45° C
CRt: ≥80	IP: 20
Color Temperature: 6500/4000/3000K	Body Size: φ180*45mm

Model No: V-WL12812R	Surface Treatment: BK
Power: SMD 12W	Life Span: 30000H
Input Voltage: AC220-240V 50/60Hz	Material: Iron+Acrylic
Luminous Flux: ≥60Lm	Working Temperature: -10~45° C
CRt: ≥80	IP: 20
Color Temperature: 6500/4000/3000K	Body Size: φ220*45mm

Model No: V-WL12810S	Surface Treatment: BK
Power: SMD 10W	Life Span: 30000H
Input Voltage: AC220-240V 50/60Hz	Material: Iron+Acrylic
Luminous Flux: ≥60Lm	Working Temperature: -10~45° C
CRt: ≥80	IP: 20
Color Temperature: 6500/4000/3000K	Body Size: 180*180*45mm

Model No: V-WL12815S	Surface Treatment: BK
Power: SMD 15W	Life Span: 30000H
Input Voltage: AC220-240V 50/60Hz	Material: Iron+Acrylic
Luminous Flux: ≥60Lm	Working Temperature: -10~45° C
CRt: ≥80	IP: 20
Color Temperature: 6500/4000/3000K	Body Size: 220*220*45mm



LED
Ceiling Fan Lamp



SOFT LIGHT / SMOOTH SOUND / REMOTE CONTROL



INTELLIGENT
DIMMER

SIX WIND
SPEED

10 M REMOTE
CONTROL

180°
WIDE-ANGLE
AIR SUPPLY

Home decor light / Ceiling Fan Lamp



MD-FLD0772RF-Y

Power: SMD 36W	Surface Treatment: Golden bronze
Input Voltage: AC220-240V 50/60Hz	Life Span: 25000H
Luminous Flux: >60Lm/W	Material: Alum+Acrylic
CRI: ≥70	Working Temperature: -10-45° C
Beam Angle: 180°	IP: 20
Color Temperature: 3 Color	Body Size: 42 Inch / Φ1080 mm

Power: SMD 36W	Surface Treatment: Golden bronze
Input Voltage: AC220-240V 50/60Hz	Life Span: 25000H
Luminous Flux: >60Lm/W	Material: Alum+Acrylic
CRI: ≥70	Working Temperature: -10-45° C
Beam Angle: 180°	IP: 20
Color Temperature: 3 Color	Body Size: 42 Inch / Φ1080 mm



MD-FLD0672RF-Y



MD-FLD0265RF-Y

Power: SMD 36W	Surface Treatment: French gold
Input Voltage: AC220-240V 50/60Hz	Life Span: 25000H
Luminous Flux: >60Lm/W	Material: Alum+Acrylic
CRI: ≥70	Working Temperature: -10-45° C
Beam Angle: 180°	IP: 20
Color Temperature: 3 Color	Body Size: 42 Inch / Φ1080 mm



Home decor light / ^{LED} Ceiling Fan Lamp

Power: SMD 36W	Surface Treatment: Silver/Golden
Input Voltage: AC220-240V 50/60Hz	Life Span: 25000H
Luminous Flux: >60Lm/W	Material: Alum+Acrylic
CRt: ≥70	Working Temperature: -10-45° C
Beam Angle: 180°	IP: 20
Color Temperature: 3 Color	Body Size: 42 Inch / φ1080 mm

MD-FLD0365RF-Y



MD-FLD0465RF-Y



Power: SMD 36W	Surface Treatment: WH
Input Voltage: AC220-240V 50/60Hz	Life Span: 25000H
Luminous Flux: >60Lm/W	Material: Alum+Acrylic
CRt: ≥70	Working Temperature: -10-45° C
Beam Angle: 180°	IP: 20
Color Temperature: 3 Color	Body Size: 42 Inch / φ1080 mm

MD-FLD0565RF-Y



Power: SMD 36W	Surface Treatment: French gold
Input Voltage: AC220-240V 50/60Hz	Life Span: 25000H
Luminous Flux: >60Lm/W	Material: Alum+Acrylic
CRt: ≥70	Working Temperature: -10-45° C
Beam Angle: 180°	IP: 20
Color Temperature: 3 Color	Body Size: 42 Inch / φ1080 mm



www.vmax.ae